

**CITY OF COSTA MESA
PUBLIC WORKS AGREEMENT
WITH JOHNSON CONTROLS FIRE PROTECTION LP
FOR
CITY HALL FIRE ALARM SYSTEM UPGRADE – PHASE II**

THIS PUBLIC WORKS AGREEMENT (“Agreement”), dated January 21, 2020 (“Effective Date”), is made by the CITY OF COSTA MESA, a political subdivision of the State of California (“CITY”), and JOHNSON CONTROLS FIRE PROTECTION LP, a Delaware limited partnership (“CONTRACTOR”).

CITY desires to construct the public work and improvements described below under Scope of Work, Paragraph 1 (“Work”).

ACCORDINGLY, the parties hereto agree as follows:

1. SCOPE OF WORK.

The Work consists of providing engineering, design, equipment, installation, and programming services to install a new Voice/Evac fire alarm system at Costa Mesa City Hall, located at 77 Fair Drive, Costa Mesa, using the Simplex 4100ES Fire Alarm Control Panel (FACP) Platform.

The Work is further described in the “Contract Documents” referred to below.

The Project is known as the City Hall Fire Alarm Upgrade Project – Phase II (“Project”).

2. CONTRACT DOCUMENTS.

The complete Agreement consists of the following documents relating to the Project:

- a. This Agreement;
- b. CONTRACTOR's proposal (Exhibit A);

- c. Complete plans;
- d. Complete specifications (Exhibit B);
- e. Certificates of Insurance;
- f. Faithful Performance Bond and Labor and Material Bond, including agent's Power of Attorney for each bond (Exhibit C);
- g. Summary of Public Contract Code section 9204 (Exhibit D);
- h. Drug-Free Workplace Policy (Exhibit E);
- i. Provisions of the most current edition of The Greenbook: Standard Specifications for Public Works Construction ("The Greenbook"); and
- j. All addenda setting forth any modifications or interpretations of the above documents.

The documents attached hereto are incorporated herein by this reference. The Greenbook is incorporated by reference as if fully set forth herein. The complete plans for the Project are on file with the Costa Mesa Fire Department and are incorporated by this reference as if fully set forth herein. The documents comprising the complete Agreement will be referred to as the "Contract Documents."

All of the Contract Documents are intended to complement one another, so that any Work called for in one and not mentioned in another is to be performed as if mentioned in all documents.

In the event of an inconsistency in the Contract Documents, the terms of this Agreement shall prevail over all other Contract Documents. The order of precedence between the remaining Contract Documents shall be as set forth in The Greenbook.

The Contract Documents constitute the entire agreement between the parties and supersede any and all other writings and oral negotiations.

3. CITY'S REPRESENTATIVE.

The CITY's Representative is Doug Lovell, referred to herein as the Project Manager ("Project Manager").

4. CONTRACTOR'S PROJECT MANAGER; PERSONNEL.

(a) Project Manager. CONTRACTOR's Project Manager must be approved by City. Such approval shall be at CITY's sole discretion.

(b) Personnel. CITY has the right to review and approve any personnel who are assigned to perform work under this Agreement. CONTRACTOR shall remove personnel from performing work under this Agreement if requested to do so by CITY.

This Paragraph 4 is a material provision of the Agreement.

5. SCHEDULE.

All Work shall be performed in accordance with the schedule approved on behalf of CITY by the Project Manager, and in accordance with the time of performance set forth in Paragraph 8 (Time of Performance).

6. EQUIPMENT - PERFORMANCE OF WORK.

CONTRACTOR shall furnish all tools, equipment, apparatus, facilities, labor and materials necessary to perform and complete the Work of construction in a good and workmanlike manner in strict conformity with the Contract Documents.

The equipment, apparatus, facilities, labor and material shall be furnished and such Work performed and completed as required in the plans and specifications to the satisfaction of the Project Manager or his or her designee, and subject to his or her approval.

7. CONTRACT PRICE.

Three Hundred Forty-Seven Thousand Six Hundred Seventeen Dollars and Twenty Cents (\$347,617.20).

8. TIME OF PERFORMANCE.

CONTRACTOR shall commence Work by the date specified in CITY's Notice to Proceed, unless a later date is agreed upon in writing by the parties. The Work shall be completed within one hundred eighty (180) days from the first day of commencement of the Work.

9. TERMINATION.

(a) Termination for Convenience.

CITY may terminate this Agreement at any time, with or without cause, by providing thirty (30) days' written notice to CONTRACTOR.

(b) Termination for Breach of Contract.

(i) If CONTRACTOR refuses or fails to prosecute the Work or any severable part of it with such diligence as will ensure its timely completion, or if CONTRACTOR fails to complete the Work on time, or if CONTRACTOR, or any subcontractor, violates any of the provisions of the Contract Documents, the Project Manager may give written notice to CONTRACTOR and CONTRACTOR's sureties of the CITY's intention to terminate this Agreement; and, unless within five (5) days after the serving of that notice, such conduct shall cease and arrangements for the correction thereof be made to the satisfaction of the CITY, this Agreement may be terminated at the option of CITY effective upon CONTRACTOR's receipt of a second notice sent by the CITY indicating that the CITY has exercised its option to terminate.

(ii) If CONTRACTOR is adjudged bankrupt or files for any relief

under the Federal Bankruptcy Code or State insolvency laws, this Agreement shall automatically terminate without any further action or notice by CITY.

(iii) If CONTRACTOR is in breach of any material provision of this Agreement, CITY may immediately terminate this Agreement by providing written notice to CONTRACTOR of same.

10. LIQUIDATED DAMAGES.

In the event the Work is not completed, for any reason, within the time required including any approved extensions of time, and to the satisfaction of the Project Manager, CITY may, in addition to any other remedies, equitable and legal, including remedies authorized by Paragraph 9 (Termination) of this Agreement, charge to CONTRACTOR or its sureties, or deduct from payments or credits due CONTRACTOR, a sum equal to two hundred fifty dollars (\$250.00) as liquidated damages for each day beyond the date provided for the completion of such Work.

The parties hereto agree that the amount set forth above, as liquidated damages constitutes a fair and reasonable estimate of the costs the CITY would suffer for each day that the CONTRACTOR fails to meet the performance schedule. The parties hereby agree and acknowledge that the delays in the performance schedule will cause CITY to incur costs and expenses not contemplated by this Agreement.

11. PERFORMANCE BY SURETIES.

In the event CONTRACTOR fails or refuses to perform the Work, CITY may provide CONTRACTOR with a notice of intent to terminate as provided in Paragraph 9 (Termination), of this Agreement. The CITY shall immediately give written notice of such intent to terminate to CONTRACTOR and CONTRACTOR's surety or sureties, and the sureties shall have the right to take over and perform this Agreement; provided, however,

that the sureties must, within five (5) days after CITY's giving notice of termination, (a) give the CITY written notice of their intention to take over the performance of this Agreement; (b) provide adequate assurances, to the satisfaction of the CITY that the Work shall be performed diligently and in a timely manner; and (c) must commence performance thereof within five (5) days after providing notice to the CITY of their intention to take over the Work. Upon the failure of the sureties to comply with the provisions set forth above, CITY may take over the Work and complete it, at the expense of CONTRACTOR, and the CONTRACTOR and the sureties shall be liable to CITY for any excess costs or damages including those referred to in Paragraph 10 (Liquidated Damages), incurred by CITY. In such event, CITY may, without liability for so doing, take possession of such materials, equipment, tools, appliances, Contract Documents and other property belonging to CONTRACTOR as may be on the site of the Work and reasonably necessary therefor and may use them to complete the Work.

12. DISPUTES PERTAINING TO PAYMENT FOR WORK.

Should any dispute arise respecting whether any delay is excusable, or its duration, or the value of the Work done, or of any Work omitted, or of any extra Work which CONTRACTOR may be required to do, or respecting any payment to CONTRACTOR during the performance of this Agreement, such dispute shall be decided by the Project Manager, and his or her decisions shall be final and binding upon CONTRACTOR and its sureties.

13. SUPERINTENDENCE BY CONTRACTOR.

At all times during performance of the Work, CONTRACTOR shall give personal superintendence or have a competent foreman or superintendent on the worksite, with authority to act for CONTRACTOR.

14. INSPECTION BY CITY.

CONTRACTOR shall at all times maintain proper facilities and provide safe access for inspection by CITY to all parts of the Work and to all shops on or off-site where the Work or portions of the Work, are in preparation. CITY shall have the right of access to the premises for inspection at all times. However, CITY shall, at all times, comply with CONTRACTOR's safety requirements on the job site.

15. CARE OF THE WORK AND OFF-SITE AUTHORIZATION.

CONTRACTOR warrants that it has examined the site of the Work and is familiar with its topography and condition, location of property lines, easements, building lines and other physical factors and limitations affecting the performance of this Agreement. CONTRACTOR, at CONTRACTOR's sole cost and expense, shall obtain any permission, and all approvals, licenses, or easements necessary for any operations conducted off the premises owned or controlled by CITY. CONTRACTOR shall be responsible for the proper care and protection of all materials delivered to the site or stored off-site and for the Work performed until completion and final inspection and acceptance by CITY. The risk, damage or destruction of materials delivered to the site or to Work performed shall be borne by CONTRACTOR.

16. PAYMENTS TO CONTRACTOR.

On or before the last Monday of each and every month during the performance of the Work, CONTRACTOR shall meet with the Project Manager or his or her designee to determine the quantity of pay items incorporated into the improvement during that month. A "Progress Payment Order" will then be jointly prepared, approved, and signed by the Project Manager and the CONTRACTOR setting forth the amount to be paid and providing for a five percent (5%) retention. Upon approval of the progress payment order

by the Project Manager, or his or her designee, it shall be submitted to CITY's Finance Department and processed for payment by obtaining approval from the City Council to issue a warrant.

Within three (3) days following City Council's approval to issue a warrant, CITY shall mail to CONTRACTOR a warrant for the amount specified in the progress payment order as the amount to be paid. The retained five percent (5%) shall be paid to CONTRACTOR thirty-five (35) days after the recording of the Notice of Completion of the Work by the COUNTY and after CONTRACTOR shall have furnished releases of all claims against CITY by persons who furnished labor or materials for the Work, if required by CITY.

Upon the request of CONTRACTOR and at its expense, securities equivalent to the amount withheld pursuant to the foregoing provisions may be presented to CITY for substitution for the retained funds. If CITY approves the form and amount of the offered securities it will release the retained funds and will hold the securities in lieu thereof. CONTRACTOR shall be entitled to any interest earned on the securities.

In the event that claims for property damage or bodily injury are presented to CITY arising out of CONTRACTOR's or any subcontractor's Work under this Agreement; CITY shall give notice thereof to CONTRACTOR, and CONTRACTOR shall have thirty-five (35) days from the mailing of any such notice to evaluate the claim and to settle it by whole or partial payment, or to reject it, and to give notice of settlement or rejection to CITY. If CITY does not receive notice within the above-mentioned 35-day period that the claim has been settled, and if the Project Manager, after consultation with the City Attorney, determines that the claim is meritorious, CITY may pay the claim or a portion of it in exchange for an appropriate release from the claimant, and may deduct the amount of the payment from

the retained funds that would otherwise be paid to CONTRACTOR upon completion of the Work; provided, however, that the maximum amount paid for any one claim pursuant to this provision shall be One Thousand Dollars (\$1,000.00), and the maximum amount for all such claims in the aggregate paid pursuant to this provision shall be Five Thousand Dollars (\$5,000.00).

17. PROMPT PAYMENT OF SUBCONTRACTORS.

The CONTRACTOR agrees to pay each subcontractor under this Agreement for satisfactory performance of its contract no later than seven (7) days from the receipt of each payment the CONTRACTOR receives from CITY.

The CONTRACTOR agrees further to release retainage payments to each subcontractor within thirty (30) days after the subcontractor's work is satisfactorily completed.

Any delay or postponement of payment from the above referenced time frame may occur only for good cause following written approval of the CITY.

18. CONTRACT SECURITY AND GUARANTEE.

Unless previously provided by CONTRACTOR to CITY, CONTRACTOR shall furnish, concurrently with the execution of this Agreement, the following: (1) a surety bond in an amount equal to one hundred percent (100%) of the contract price as security for the faithful performance of this Agreement, and (2) a separate surety bond in an amount equal to at least one hundred percent (100%) of the contract price as security for the payment of all persons furnishing labor or materials in connection with the Work under this Agreement. Sureties for each of the bonds and the forms thereof shall be satisfactory to CITY. In addition, such sureties must be authorized to issue bonds in California; sureties must be listed on the latest revision to the U.S. Department of the Treasury

Circular 570; and must be shown to have sufficient bonding capacity to provide the bonds required by the Contract Documents.

CONTRACTOR shall provide a certified copy of the certificate of authority of the surety issued by the Insurance Commissioner; a certificate from the clerk of the county in which the court or officer is located that the certificate of authority of the surety has not been surrendered, revoked, canceled, annulled, or suspended or, in the event that it has, that renewed authority has been granted; and copies of the surety's most recent annual statement and quarterly statement filed with the Department of Insurance pursuant to Article 10 (commencing with Section 900) of Chapter 1 of Part 2 of Division 1 of the Insurance Code.

CONTRACTOR guarantees that all materials used in the Work and all labor performed shall be in conformity with the Contract Documents including, but not limited to, the standards and specifications set forth in the most current edition of The Greenbook. CONTRACTOR shall, at its own expense, make any and all repairs and replacements that shall become necessary as the result of any failure of the Work to conform to the aforementioned Contract Documents, and standard specifications; provided, however, that CONTRACTOR shall be obligated under this provision only to the extent of those failures or defects of which he is given notice within a period of twelve (12) months from the date that the Notice of Completion is recorded.

The rights and remedies available to CITY pursuant to this provision shall be cumulative with all rights and remedies available to CITY pursuant to statutory and common law, which rights and remedies are hereby expressly reserved, and neither the foregoing guarantee by CONTRACTOR nor its furnishing of the Bonds, nor acceptance thereof by CITY, shall constitute a waiver of any rights or remedies available to CITY

against CONTRACTOR.

19. INDEMNIFICATION.

CONTRACTOR agrees to protect, defend, indemnify and hold harmless CITY and its elected and appointed boards, officers, agents, and employees from any and all claims, liabilities, expenses, or damages of any nature, including attorney fees, for injury to or death of any person, and for injury or damage to any property, including consequential damages of any nature resulting therefrom, arising out of or in any way connected with the performance of this Agreement. The defense obligation provided for hereunder shall apply without any advance showing of negligence or wrongdoing by the CONTRACTOR, its employees, and/or authorized subcontractors, but shall be required whenever any claim, action, complaint, or suit asserts as its basis the negligence, errors, omissions or misconduct of the CONTRACTOR, its employees, and/or authorized subcontractors, and/or whenever any claim, action, complaint or suit asserts liability against the CITY, its elected officials, officers, agents and employees based upon the work performed by the CONTRACTOR, its employees, and/or authorized subcontractors under this Agreement, whether or not the CONTRACTOR, its employees, and/or authorized subcontractors are specifically named or otherwise asserted to be liable. Notwithstanding the foregoing, the CONTRACTOR shall not be liable for the defense or indemnification of the CITY for claims, actions, complaints or suits arising out of the sole active negligence or willful misconduct of the CITY. This provision shall supersede and replace all other indemnity provisions contained either in the CITY's specifications or CONTRACTOR's proposal, which shall be of no force and effect.

CONTRACTOR shall comply with all of the provisions of the Workers' Compensation insurance laws and Safety in Employment laws of the State of California,

including the applicable provisions of Divisions 4 and 5 of the California Labor Code and all amendments thereto and regulations promulgated pursuant thereto, and all similar State, Federal or local laws applicable; and CONTRACTOR shall indemnify and hold harmless CITY from and against all claims, liabilities, expenses, damages, suits, actions, proceedings and judgments, of every nature and description, including attorney fees, that may be presented, brought or recovered against CITY for or on account of any liability under or failure to comply with any of said laws which may be incurred by reason of any Work performed under this Agreement by CONTRACTOR or any subcontractor or others performing on behalf of CONTRACTOR.

CITY does not, and shall not, waive any rights against CONTRACTOR which it may have by reason of the above hold harmless agreements, because of the acceptance by CITY or the deposit with CITY by CONTRACTOR of any or all of the insurance policies described in Paragraph 20 (Insurance) of this Agreement.

The hold harmless agreements by CONTRACTOR shall apply to all liabilities, expenses, claims, and damages of every kind (including but not limited to attorney fees) incurred or alleged to have been incurred, by reason of the operations of CONTRACTOR or any subcontractor or others performing on behalf of CONTRACTOR, whether or not such insurance policies are applicable. CONTRACTOR shall require any and all tiers of subcontractors to afford the same degree of indemnification to the CITY OF COSTA MESA and its elected and appointed boards, officers, agents, and employees that is required of CONTRACTOR and shall incorporate identical indemnity provisions in all contracts between CONTRACTOR and all tiers of its subcontractors.

In the event that CONTRACTOR and CITY are sued by a third party for damages caused or allegedly caused by negligent or other wrongful conduct of CONTRACTOR, or

by a dangerous condition of CITY's property created by CONTRACTOR or existing while the property was under the control of CONTRACTOR, CONTRACTOR shall not be relieved of its indemnity obligation to CITY by any settlement with any such third party unless that settlement includes a full release and dismissal of all claims by the third party against the CITY.

20. INSURANCE.

CONTRACTOR shall not commence Work under this Agreement until it has obtained all insurance required under this section and CITY has approved the insurance as to form, amount, and carrier, nor shall CONTRACTOR allow any subcontractor to commence any Work until all similar insurance required of the subcontractor has been obtained and approved.

Neither the failure of CONTRACTOR to supply specified insurance policies and coverage, nor the failure of CITY to approve same shall alter or invalidate the provisions of Paragraph 19 (Indemnification) of this Agreement.

(a) Workers' Compensation Insurance.

CONTRACTOR shall obtain and maintain during the life of this Agreement workers' compensation insurance and, if any Work is sublet, CONTRACTOR shall require all tiers of subcontractors to obtain workers' compensation insurance.

All workers' compensation insurance policies shall provide that the insurance may not be canceled without thirty (30) days' advance written notice of such cancellation to CITY.

CONTRACTOR agrees to waive, and obtain endorsements from its workers' compensation insurer waiving, subrogation rights under its workers' compensation insurance policy against the CITY and to require each of its subcontractors,

if any, to do likewise under their workers' compensation insurance policies.

(b) Liability Insurance Coverage.

CONTRACTOR shall obtain and maintain during the life of this Agreement the following insurance coverage:

(i) Commercial General Liability, including coverage for premises-operations, products/completed operations hazard, blanket contractual, broad form property damage, and independent contractors. In addition, CONTRACTOR shall obtain and maintain during the life of this Agreement each of the following insurance coverage which are not stricken out and initialed by the Project Manager: Explosion and collapse hazard, underground hazard, personal injury, and automobile liability, including owned, hired, and non-owned vehicles. All insurance coverage shall have limits of not less than \$1,000,000.00 combined single limits, per occurrence and aggregate.

(ii) Below are approved endorsements which satisfy the basic insurance requirements contained in contracts entered into by City of Costa Mesa. These have been approved by the City Attorney's Office. The terms of any specific contract with the City are controlling. Prior to the commencement of any work, the City requires that the Engineer receive Certificates of Insurance in DUPLICATE for liability coverage of at least \$1,000,000.00 combined single limits, per occurrence and in the aggregate. Endorsements to the policies providing the above insurance shall be obtained by CONTRACTOR, adding the following three provisions:

(1) Additional Insured:

"The City of Costa Mesa and its elected and appointed boards, officers, agents, and employees are additional insureds with respect to the subject project and agreement."

(2) Notice:

“Said policy shall not terminate, nor shall it be canceled nor the coverage reduced, until thirty (30) days after written notice is given to CITY.”

(3) Other Insurance:

“Any other insurance maintained by the City of Costa Mesa shall be excess and not contributing with the insurance provided by this policy.”

If any of such policies provide for a deductible or self-insured retention to provide such coverage, the amount of such deductible or self-insured retention shall be approved in advance by CITY. No policy of insurance issued as to which the CITY is an additional insured shall contain a provision which requires that no insured except the named insured can satisfy any such deductible or self-insured retention.

21. PROOF OF INSURANCE.

Prior to commencement of the Work, CONTRACTOR shall furnish CITY, through the Project Manager, proof of compliance with the above insurance requirements in a form satisfactory to the Risk Management.

22. LEGAL WORK DAY - PENALTIES FOR VIOLATION.

Eight (8) hours of labor shall constitute a legal day's work during any one (1) calendar day. CONTRACTOR shall forfeit to CITY the sum of Twenty-Five Dollars (\$25.00) for each workman employed in the execution of this Agreement by CONTRACTOR or by any subcontractor for each calendar day during which such workman is required or permitted to work more than eight (8) hours in any one calendar day and 40 hours in any one calendar week in violation of California Labor Code Sections 1810 through 1815, inclusive.

23. PREVAILING WAGE SCALE.

CONTRACTOR shall comply in all respects with the Davis-Bacon Act (40 U.S.C. section 276a) and with California Labor Code sections 1770 et seq., including the keeping of all records required by the provisions of Labor Code section 1776.

CONTRACTOR shall furnish each week to CITY's Project Administration Division a statement with respect to the wages of each of its employees during the preceding weekly payroll period.

24. COMPLIANCE WITH ALL LAWS.

CONTRACTOR shall, at its own cost and expense, comply with all applicable local, state, and federal laws, regulations, and requirements in the performance of this Agreement, including but not limited to laws regarding health and safety, labor and employment, and wage and hours.

25. DRUG-FREE WORKPLACE POLICY.

CONTRACTOR, upon notification of the award of this Agreement, shall establish a Drug-Free Awareness Program to inform employees of the dangers of drug abuse in the workplace, the penalties that may be imposed upon employees for drug abuse violations occurring in the workplace, and the employee assistance programs available to employees. Each employee engaged in the performance of a CITY contract must be notified of this Drug-Free Awareness Program, and must abide by its terms. CONTRACTOR shall conform to all the requirements of CITY's Policy No. 100-5, attached hereto. Failure to establish a program, notify employees, or inform the CITY of a drug-related workplace conviction will constitute a material breach of contract and cause for immediate termination of the contract by the CITY.

26. NON-DISCRIMINATION.

In performing this Agreement, CONTRACTOR will not engage in, nor permit its agents to engage in, discrimination in employment of persons because of their race, religion, color, national origin, ancestry, physical handicap, medical condition, marital status or sex, or sexual orientation, except as permitted pursuant to Section 12940 of the Government Code. Violation of this provision may result in the imposition of penalties referred to in Section 1735 of the California Labor Code.

27. CONTRACT ASSURANCE.

The CONTRACTOR or subcontractor shall not discriminate on the basis of race, color, national origin, or sex in the performance of this Agreement. The CONTRACTOR shall carry out applicable requirements of 49 CFR part 26 in the award and administration of DOT-assisted contracts. Failure by the CONTRACTOR to carry out these requirements is a material breach of this Agreement, which may result in the termination of this Agreement or such other remedy as recipient deems appropriate.

The CONTRACTOR will require that the above provision is included in all subcontracts.

28. PROVISIONS CUMULATIVE.

The provisions of this Agreement are cumulative and in addition to, and not in limitation of, any other rights or remedies available to CITY.

29. NOTICES.

It shall be the duty and responsibility of CONTRACTOR to notify all tiers of subcontractors and material men of the following special notice provision; namely, all preliminary 20-day notices or stop notices shall be directed only to the City Clerk and to no other department, and shall be either personally delivered or sent by certified mail,

postage prepaid.

All other notices shall be in writing and delivered in person or sent by certified mail, postage prepaid. Notices required to be given to CITY pursuant to this Agreement shall be addressed as follows:

City of Costa Mesa
77 Fair Drive
Costa Mesa, CA 92626
Attn: Doug Lovell

Notices required to be given to CONTRACTOR shall be addressed as follows:

Johnson Controls Fire Protection LP
12728 Shoemaker Ave. Bldg. C
Santa Fe Springs, CA 90670
Attn: Walter Corcio

Notices required to be given to CONTRACTOR's sureties shall be addressed as follows:

Federal Insurance Company
818 West Seventh Street, Suite 930
Los Angeles, CA 90017
Attn: Vivian Imperial

30. INDEPENDENT CONTRACTOR.

The parties hereto acknowledge and agree that the relationship between CITY and CONTRACTOR is one of principal and independent contractor and no other. All personnel to be utilized by CONTRACTOR in the performance of this Agreement shall be employees of CONTRACTOR and not employees of the CITY. CONTRACTOR shall pay all salaries and wages, employer's social security taxes, unemployment insurance and similar taxes relating to employees and shall be responsible for all applicable withholding taxes. Nothing contained in this Agreement shall create or be construed as creating a partnership, joint venture, employment relations, or any other relationship except as set forth between the parties. The parties specifically acknowledge and agree that

CONTRACTOR is not a partner with CITY, whether general or limited, and no activities of CITY or CONTRACTOR or statements made by CITY or CONTRACTOR shall be interpreted by any of the parties hereto as establishing any type of business relationship other than an independent contractor relationship.

31. PERS ELIGIBILITY INDEMNIFICATION.

In the event that CONTRACTOR or any employee, agent, or subcontractor of CONTRACTOR providing services under this Agreement claims or is determined by a court of competent jurisdiction or the California Public Employees' Retirement System (PERS) to be eligible for enrollment in PERS as an employee of the CITY, CONTRACTOR shall indemnify, defend, and hold harmless CITY for the payment of any employee and/or employer contributions for PERS benefits on behalf of CONTRACTOR or its employees, agents, or subcontractors, as well as for the payment of any penalties and interest on such contributions, which would otherwise be the responsibility of CITY.

Notwithstanding any other agency, state or federal policy, rule, regulation, law or ordinance to the contrary, CONTRACTOR and any of its employees, agents, and subcontractors providing service under this Agreement shall not qualify for or become entitled to, and hereby agree to waive any claims to, any compensation, benefit, or any incident of employment by CITY, including but not limited to eligibility to enroll in PERS as an employee of CITY and entitlement to any contribution to be paid by CITY for employer contribution and/or employee contributions for PERS benefits.

32. VALIDITY.

The invalidity in whole or in part of any provision of this Agreement shall not void or affect the validity of any of the other provisions of this Agreement.

33. GOVERNING LAW.

This Agreement shall be governed by and construed in accordance with the laws of the State of California. Any legal action relating to or arising out of this Agreement shall be subject to the jurisdiction of the County of Orange, California.

34. RESOLUTION OF CONTRACTOR CLAIMS.

CONTRACTOR claims, as defined in California Public Contract Code section 9204, shall be resolved in accordance with the provisions of Section 9204 and applicable law. A summary of Section 9204 is attached hereto and incorporated herein by reference.

35. NO THIRD PARTY BENEFICIARY RIGHTS.

This Agreement is entered into for the sole benefit of the CITY and CONTRACTOR and no other parties are intended to be direct or incidental beneficiaries of this Agreement and no third party shall have any right in, under or to this Agreement.

36. ASSIGNABILITY.

This Agreement may not be sold, transferred or assigned by either party, or by operation of law, to any other person or persons or business entity, without the other party's written permission. Any such sale, transfer or assignment, or attempted sale, transfer or assignment without written permission, may be deemed by the other party to constitute a voluntary termination of this Agreement and this Agreement shall thereafter be deemed terminated and void.

37. WAIVER.

No waiver of any provision of this Agreement shall be effective unless in writing and signed by a duly authorized representative of the party against whom enforcement of a waiver is sought referring expressly to this Paragraph. The waiver of any right or remedy in respect to any occurrence or event shall not be deemed a waiver of any right

or remedy in respect to any other occurrence or event, nor shall any waiver constitute a continuing waiver.

38. HEADINGS.

Section and subsection headings are not to be considered part of this Agreement, are included solely for convenience, and are not intended to modify or explain or to be a full or accurate description of the content thereof.

39. COUNTERPARTS.

This Agreement may be executed in one or more counterparts by the parties hereto. All counterparts shall be construed together and shall constitute one Agreement.

40. CORPORATE AUTHORITY.

The persons executing this Agreement on behalf of the Parties hereto warrant that they are duly authorized to execute this Agreement on behalf of said Parties and that by doing so, the Parties hereto are formally bound to the provisions of this Agreement.

41. ADDITIONAL SERVICES.

CONTRACTOR shall not receive compensation for any services provided outside the scope of the Contract Documents unless such additional services, including change orders, are approved in writing by CITY prior to CONTRACTOR performing the additional services.

It is specifically understood that oral requests or approvals of such additional services, change orders or additional compensation and any approvals from CITY shall be barred and are unenforceable.

[Signatures appear on following page.]

IN WITNESS WHEREOF, the parties hereto have caused this Agreement to be executed by and through their respective authorized officers, as of the date first above written.

CITY OF COSTA MESA,
A municipal corporation



Lori Ann Farrell Harrison
City Manager

Date: 2/27/20

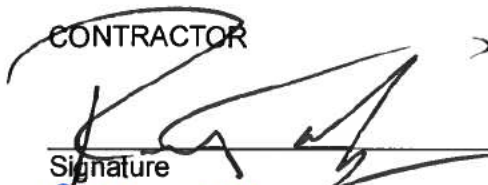
CONTRACTOR

Signature
Robert Mays
Area Installation Manager
Name and Title

Date: 1/28/2020

Social Security or Taxpayer ID Number

ATTEST:



Brenda Green
City Clerk



Date: 3/3/2020

APPROVED AS TO FORM:

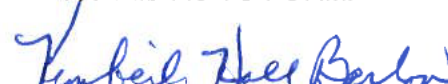

Kimberly Hall Barlow
City Attorney

Date: 2/11/20

APPROVED AS TO INSURANCE:



Ruth Wang
Risk Management

Date: 2/6/2020

APPROVED AS TO PURCHASING:



Kelly A. Telford
Finance Director

Date: 2/5/2020

DEPARTMENTAL APPROVAL:



Raja Sethuraman
Public Services Director

Date: 2-10-2020

for 

Doug Lovell
Project Manager

Date: 02/07/2020

EXHIBIT A
CONTRACTOR'S PROPOSAL



12728 Remaker Ave
SANTA ANA SPRINGS, CA 90670-6345
(562) 405 3800
FAX: (562) 405 3801

Johnson Controls Quotation

TO:
City of Costa Mesa - City Hall
77 Fair Drive
COSTA MESA, CA 92626-6546

Project: Costa Mesa-FA Phase II
Customer Reference:
Johnson Controls Reference: 434430457
Date: 09/18/2019

Johnson Controls is pleased to offer for your consideration this quotation for the above project.

SCOPE OF WORK

Reference:
CITY OF COSTA MESA-CITY HALL
77 Fair Drive
Costa Mesa, CA. 92626

Scope of Work: City Hall Fire Alarm System-Phase II

Johnson Controls Fire Protection, LP proposes to provide engineering, design, equipment, installation, and programming services to install a new Voice/Evac fire alarm system using the Simplex 4100ES Fire Alarm Control Panel (FACP) Platform at the above referenced location.

Conditions:

- a) Work shall not be performed until contract/purchase order has been fully executed and approved.
- b) Project will require engineered plan check and submittals. Engineering of plans and permit costs are included. No work shall be performed until approvals have been received. The liability for any work prior to approvals shall be the sole responsibility of the owner/company requesting said work.
- c) Invoicing shall be monthly, based on progress of labor and material. Johnson Controls Fire Protection, LP reserves the right to stop work when any invoice exceeds 30 days past due.
- d) Lead time on engineered plans is normally 2 to 3 weeks after a fully executed contract and a usable CAD format floor plan is received.
- e) Lead time on equipment is normally 2 to 3 weeks once drawings are approved by the Authority Having Jurisdiction (AHJ) (special orders and/or other vendor items may require additional lead time).
- f) Pre-test and final test with State Fire Marshal.
- g) Johnson Controls Fire Protection, LP will provide a wireless communicator for Central Station monitoring.
- h) Central Station monitoring proposal will be provided as a separate proposal and is not part of this proposal.

Exclusions:

1. All 120VAC electrical power/wiring to be provided by others.
2. Phone lines required for 24/7 Monitoring.
3. PE Stamps or Seismic Structural Calculations.

THIS QUOTATION AND ANY RESULTING CONTRACT SHALL BE SUBJECT TO THE GENERAL TERMS AND CONDITIONS ATTACHED HERETO.

Fire, Security, Communications, Sales & Service
Offices & Representatives in Principal Cities throughout North America

© 2018 Johnson Controls. ALL RIGHTS RESERVED.



Project: Costa Mesa-FA Ph
 Customer Reference:
 Johnson Controls Reference: 434430457
 Date: 09/18/2019

Johnson Controls Quotation

SCOPE OF WORK (continued)

4. Painting, Patching, Ceiling Tile replacement or Concrete Coring.
5. Parking and power to be provided.
6. An area for storage of equipment shall be provided.
7. Any removal of hazardous substances or working in a hazardous environment such as, but not limited to, asbestos, carbon monoxide or methane.
8. After hours testing.
9. Bond fees or fire watch.
10. Firemen phone jacks
11. Distributed Antenna System "DAS"

This proposal is valid for 30days.
 Thank you for the opportunity to submit our proposal.

Fire Alarm

QTY	MODEL NUMBER	DESCRIPTION	UNIT PRICE	EXT. PRICE
System FA using New Take-Off S				
New Material List Row				
234	4098-9792	SENSOR BASE	55.66	13,024.44
234	4098-9714	PHOTO SENSOR	42.87	10,031.58
83	4098-9792	SENSOR BASE	55.66	4,619.78
83	4098-9733	HEAT SENSOR	27.90	2,315.70
24	4090-9008	DUAL RELAY IAM, IDNET	169.06	4,057.44
12	4090-9001	SUPERVISED IAM	55.74	668.88
44	49VO-WWF	VO Wall White FIRE	35.95	1,581.80
53	4906-9253	MC TRUEALERT S/V WALL MT WHITE	61.19	3,243.07
4	4009-9401	4009 ADDRESSABLE CONTROLLER	994.52	3,978.08
16	DH24120FPC	DR HLD, SEMI-FLUSH, CHRM	30.99	495.84
1	4098-9019	ADDRESS BEAM DETECTOR SYSTEM	939.47	939.47
1	DPFA	DP FIRE ALARM - MATERIALS	24,320.36	24,320.36
	SALES TAX			5,368.92
EET Prof. Services				
Professional Services				
	DSGN LAB	DESIGN LABOR		3,006.60
	CAD LAB	CAD LABOR		3,899.67
	PM LAB	PROJECT/CONSTRUCTION MGMT		5,482.00
EET Tech. Services				
Technical Services				
	COMM LAB	COMMISSIONING LABOR		4,043.60

Fire, Security, Communications, Sales & Service
 Offices & Representatives in Principal Cities throughout North America



Project: Costa Mesa-FA P/) II
 Customer Reference:
 Johnson Controls Reference: 434430457
 Date: 09/18/2019

Johnson Controls Quotation

QTY	MODEL NUMBER	DESCRIPTION	UNIT PRICE	EXT. PRICE
		EET Subcontract Section		
		EET Misc Items		
DPSVC		Permits/Approvals		1,406.47
		EET Installation Services		
		Installation Services		
INST LAB		INSTALLATION LABOR		254,922.64
		System Record Docs. Cabinet		
		System Record Docs. Cabinet		
1	SSU00677	CAB DOC STOR 26X14X4D RED	195.69	195.69
	SALES TAX			15.17
	SALES TAX			5,384.09

Total net selling price, Sales Tax Included, \$347,617.20

Fire, Security, Communications, Sales & Service
 Offices & Representatives in Principal Cities throughout North America

© 2018 Johnson Controls. ALL RIGHTS RESERVED.

EXHIBIT B
SPECIFICATIONS



FIRE ALARM SYSTEM PRODUCT SUBMITTAL

City Hall Costa Mesa
77 fair dr
Costa Mesa, CA 92626

Submittal Prepared By:

Johnson Controls Fire Protection, LP
12728 Shoemaker Ave.
Santa Fe Springs, CA 90670

PH: (562) 405-3800

FX: (562) 405-3801

Prepared By:

LH

Date Prepared:

10.10.2018



FIRE ALARM SYSTEM PRODUCT SUBMITTAL

City Hall Costa Mesa
77 fair dr
Costa Mesa, CA 92626

Product ID	Description	Manufacture	C.S.F.M.
FIRE ALARM CONTROL PANELS, ANNUNCIATORS AND BATTERIES			
4100-8311 LE4010CF-AT	4100ES FIRE ALARM CONTROL PANEL CELLULAR COMMERCIAL DIALER	SIMPLEX OSC	7165-0028:0251 7300-1273:0506
INITIATING DEVICES			
4099-9021 4098-8714 4098-9792	IDNET NO GRIP MANUAL PULL STATION, LED TRUEALARM PHOTO SMOKE SENSOR TRUE ALARM SENSOR BASE	SIMPLEX SIMPLEX SIMPLEX	7160-0026:0224 7272-0028:0218 7300-0026:0217
NOTIFICATION DEVICES			
MB-G6-24-R	MOTOR BELL - 6" - 24VDC - RED	SYSTEM SENSOR	7135-0785:0113

Job Number: 434-608437601
 Prepared By: LH
 Date: 10.10.2018

Simplex

UL, ULC, CSFM Listed;
FM Approved*



4100ES Fire Control Panels

Addressable Fire Detection and Control
Basic Panel Modules and Accessories

Features

Master Controller (top) bay standard equipment:

- 32-Bit Master Controller with color-coded operator interface and raised switches for high confidence feedback
- Dual configuration program CPU, convenient service port access, and capacity for up to 2500 addressable points
- CPU assembly includes 2 GB dedicated compact flash memory for on-site system programming and information storage
- An Enhanced Power Supply (EPS) and battery charger (9 A total) with on-board IDNAC SLCs (signaling line circuit) for addressable appliance control, an IDNet 2 Module for addressable device control; and programmable function auxiliary output
- Also available with InfoAlarm Command Center expanded content user interface (see data sheet S4100-0045)

Standard addressable device interfaces include:

- 250 point addressable device IDNet 2 SLC that supports TrueAlarm analog sensors and IDNet communications monitoring and control devices with an *electrically isolated output channel* allowing use with either shielded or unshielded, twisted or untwisted single pair wiring; and *providing dual short circuit isolating output loops*
- MINIPLEX Transponder and remote LCD and LED annunciator support via RUI+ (remote unit interface) communications port with *electrically isolated output* for use with either shielded or unshielded, twisted or untwisted single pair wiring (refer to details on page 6)

Standard power supplies (EPS) provide enhanced power delivery IDNAC SLCs to addressable notification appliances:

- With IDNAC SLCs, a constant 29 VRMS source voltage is maintained, even during battery standby, allowing strobes to operate at higher voltage with lower current and ensuring a consistent current draw and voltage drop margin under both primary power and secondary battery standby
- Efficiencies include lower strobe currents, wiring distances up to 2 to 3 times farther than with conventional notification, support for more appliances per IDNAC SLC, and the ability to use smaller gauge wiring – all providing installation and maintenance savings with high assurance that appliances that operate during normal system testing will also operate during worst case alarm conditions
- IDNAC SLCs are compatible with both TrueAlert ES and TrueAlert addressable notification appliances, and remote 4009 IDNAC Repeaters to extend power and wiring distance even farther

Optional modules and connections include:

- Fire Alarm Network Interfaces, city connections, and up to five (5) RS-232 ports for printers and terminals
- Building Network Interface Module (BNIC) for Ethernet connectivity options (see data sheet S4100-0061)
- Side mounted DACT assembly requiring minimal panel space; DACT is compatible with IP Communicators
- Emergency communications systems (ECS) equipment; 8 channel digital audio or 2 channel analog audio

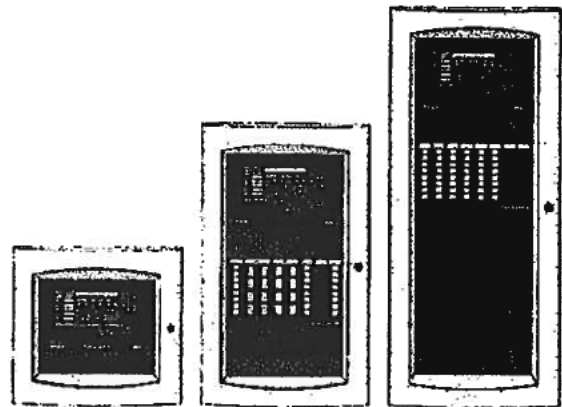

4100ES Cabinets are Available with One, Two or Three Bays

Option Modules (Continued)

- Additional IDNet 2 communications SLCs, IDNet 2+2 Modules with quad short circuit isolating output loops; additional power supplies, alarm relays, and auxiliary relays
- LED/switch modules and panel mount printers; VESDA Air Aspiration Systems interface, ASHRAE BACnet Interface, TCP/IP Bridges
- Battery brackets for seismic area protection (see page 2)
- 4100ES compatible legacy interface modules, including control of conventional (non-addressable) NACS (see data sheet reference list on page 9)

4100ES Listings reference:

- UL 864, Fire Detection and Control (UOJZ), and Smoke Control Service (UUKL)
- UL 2017, Process Management Equipment (QVAX)
- UL 1076, Proprietary Alarm Units-Burglar (APOU)
- UL 1730, Smoke Detector Monitor (UULH)
- UL 2572, Mass Notification Systems (PGWM); refer to data sheet S4100-0034 for audio equipment
- ULC S527, Control Units for Fire Alarm Systems

Software Feature Summary

CPU provides dual configuration programs:

- Two programs allow for optimal system protection and commissioning efficiency with one active program and one reserve; downtime is reduced because the system stays running during download

PC based programmer features:

- Convenient front panel accessed Ethernet port for quick and easy *download* of site-specific programming
- Modifications can be *uploaded* as well as downloaded for greater service flexibility; *AND*, firmware enhancements are made via software downloads to the on-board flash memory

* See pages 6 and 7 for product that is UL or ULC listed and additional listing information. This product has been listed by the California State Fire Marshal (CSFM) pursuant to Section 13144.1 of the California Health and Safety Code. See CSFM Listing 7165-0026:0251 for allowable values and/or conditions concerning material presented in this document. Additional listings may be applicable; contact your local Simplex product supplier for the latest status. Listings and approvals under Simplex Time Recorder Co. are the property of Tyco Fire Protection Products.

Addressable Manual Station Product Selection

Addressable Manual Stations, Red Housing with White Letters and White Pull Lever

Model	Description	Housing	Pull Lever	Listings
4099-9004	Single Action, English	FIRE ALARM	PULL DOWN	UL, ULC, FM, CSFM
4099-9004CB	Single Action, Bilingual English and French	FEU FIRE	TIREZ PULL	ULC
4099-9004CF	Single Action, French	ALARME FEU	ABAISEZ	
4099-9004PO	Single Action, Portuguese	FOGO ALARME	PUXE	UL, FM
4099-9004SP	Single Action, Spanish	ALARMA FUEGO	JALE	
4099-9005	Double Action, Breakglass operation, English	FIRE ALARM	PULL DOWN	UL, ULC, FM, CSFM
4099-9005PO	Double Action, Breakglass operation, Portuguese	FOGO ALARME	PUXE	UL, FM
4099-9005SP	Double Action, Breakglass operation, Spanish	ALARMA FUEGO	JALE	
4099-9006	Double Action, Push operation, English	FIRE ALARM	PUSH PULL DOWN	UL, ULC, FM, CSFM
4099-9006PO	Double Action, Push operation, Portuguese	FOGO ALARME	EMPURRE PUXE	UL, FM
4099-9006SP	Double Action, Push operation, Spanish	ALARMA FUEGO	EMPUJE JALE	
4099-9021	Single Action NO GRIP operation, English	FIRE ALARM	PULL DOWN	UL, ULC, FM, CSFM

Accessories (refer to pages 3 and 4 for details)

Model	Description	Model	Description
2975-9022	Cast aluminum surface mount box, red	2099-9803	Replacement breakglass
2875-9178	Surface mount steel box, red	2099-9804	Replacement break-rod
2099-9813	Semi-flush trim plate for double gang switch box, red	2099-9828	Institutional cover kit for field installation on 4099-9004; Note: Covers LED indicator
2099-9819	Flush mount adapter kit, black	2099-9814	Surface trim plate for Wiremold box V5744-2, red
2099-9820	Flush mount adapter kit, beige		
4099-9805	Retrofit Kit for field conversion of a single action station to a NO GRIP station; refer to Installation Instructions 579-1007 for details		

Specifications (refer to Installation Instructions 579-1135 for additional information)

Power and Communications	IDNet or MAPNET II communications, 1 address per station
Address Means	DIP switch, 8 position
Wire Connections	Screw terminal for in/out wiring, for 18 to 14 AWG wire (0.82 mm ² to 2.08 mm ²)
UL Listed Temperature Range	32° to 120° F (0° to 49° C) intended for indoor operation
Humidity Range	Up to 93% RH at 100° F (38° F)
Housing Color	Red with white raised lettering
Material	Housing and pull lever are Lexan polycarbonate or equal
Pull Lever Color	White with red raised lettering
Housing Dimensions	5" H x 3 3/4" W x 1" D (127 mm x 95 mm x 25 mm)

Addressable Manual Station Semi-Flush Mounting

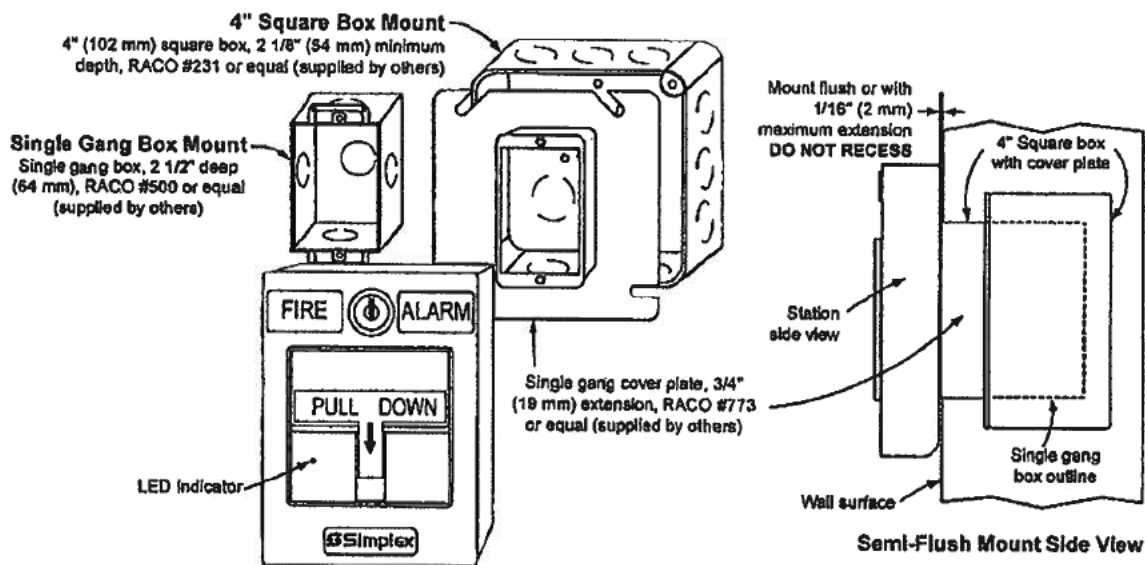

Addressable Manual Station, Additional Mounting Information

For retrofit and new installations, additional compatible mounting boxes and the required adapter plates are shown in the illustration to the right.

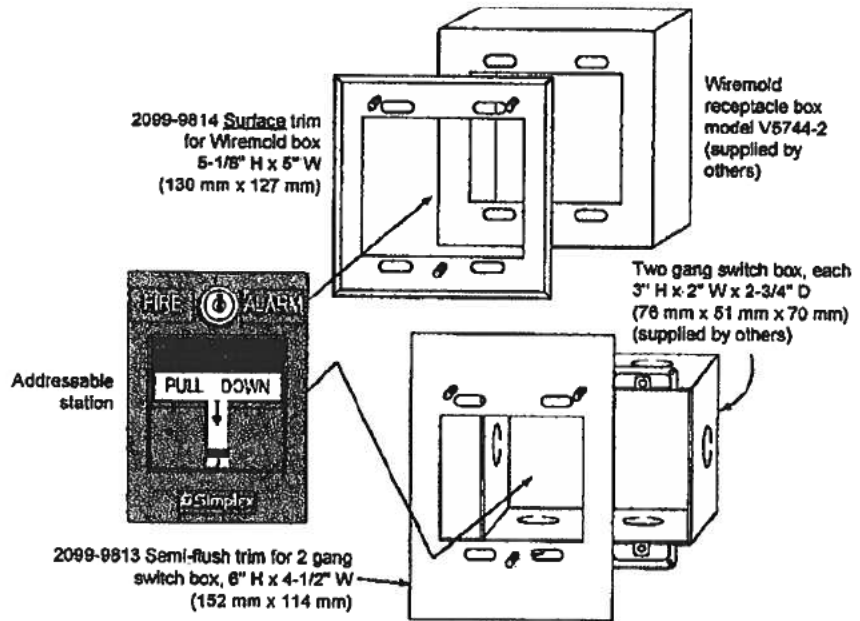

Addressable Manual Station, Flush Mounting Information

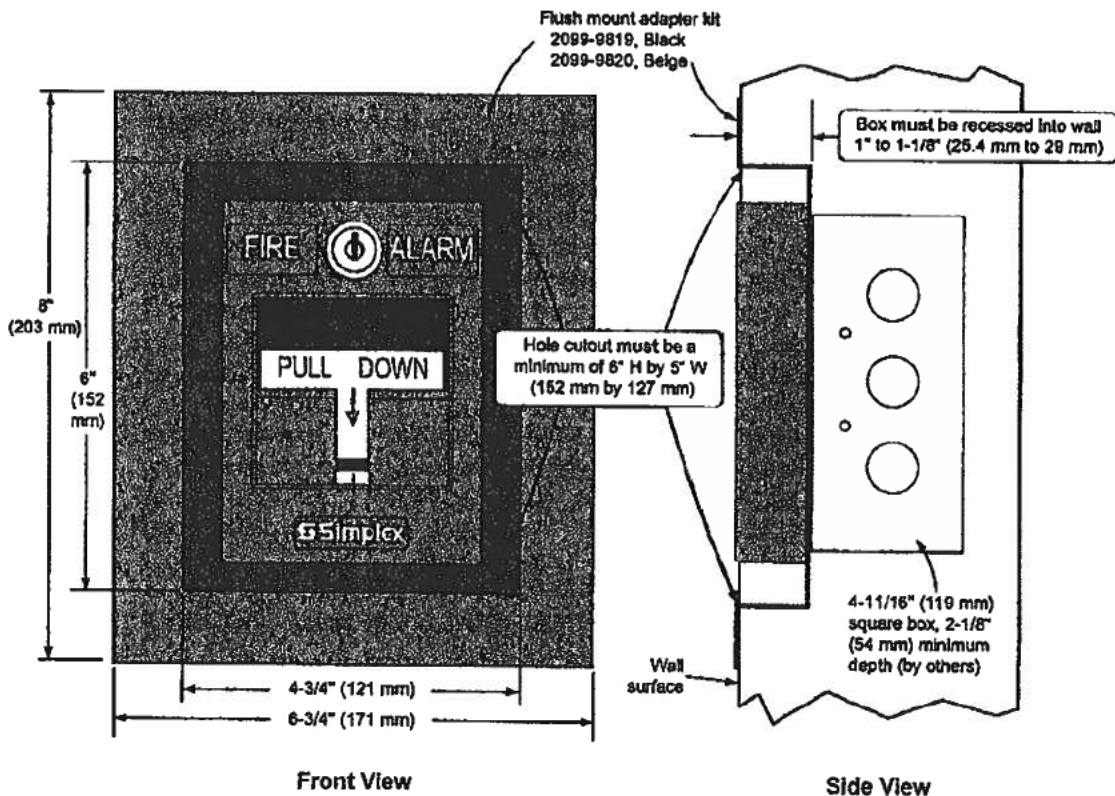

TYCO, SIMPLEX, and the product names listed in this material are marks and/or registered marks. Unauthorized use is strictly prohibited. NFPA 72 and National Fire Alarm and Signaling Code are trademarks of the National Fire Protection Association (NFPA). Lexau is a trademark of the General Electric Co. Wiremold is a trademark of the Wiremold Company.

Simplex

Tyco Fire Protection Products • Westminister, MA • 01441-0001 • USA

S4099-0005 10/2014

www.simplex-fire.com

© 2014 Tyco Fire Protection Products. All rights reserved. All specifications and other information shown were current as of document revision date and are subject to change without notice.

Architects and Engineers Specifications

The audible signal appliances shall be Wheelock Series MB vibrating Motor Bells or approved equal. Shells shall be aluminum in 6" or 10" diameter. Sound output at 10 feet shall be 92 dBA @ 10 feet. The bells shall incorporate a permanent magnet motor and provide the necessary suppression to minimize RFI. They shall include a built-in trimplate for semi-flush mounting to standard 4" square backboxes, or surface mounting to Wheelock's indoor BB backbox or outdoor WBB backbox.

Model Number	Order Code	Nominal Voltage (VDC)	Strobe Candela	Average Current (AMPS) at listed VDC	UL Max*	**Mounting Options
RSSP-24MCW-FR	9402	24	15/30/75/110	.041/.063/.109/.140	.060/.092/.165/.220	D,E,Z
RSSP-241575W-FR	7793	24	15 (75 on-axis)	.060	.090	D,E,Z
RSSP-121575W-FR	7798	12	15 (75 on-axis)	.152	.255	D,E,Z

Note: For more information on the Series RSSP-24MCW-FR, see data sheet S0410C or Installation Instructions P83911.

*Average Current per actual Wheelock Production Testing at listed VDC. For Rated Average and Peak current across UL regulated voltage range for both Filtered DC and Unfiltered VRMS, see Installation Instructions

** Refer to Data Sheet S7000 for Mounting Options

#DSM Sync Module is rated for 3.0 amperes per circuit. The maximum number of interconnected DSM modules is twenty (20). Refer to Data Sheet S3000C or Installation Instructions P83177 for DSM.

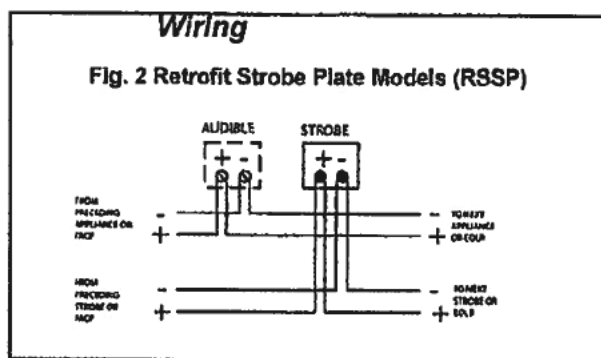
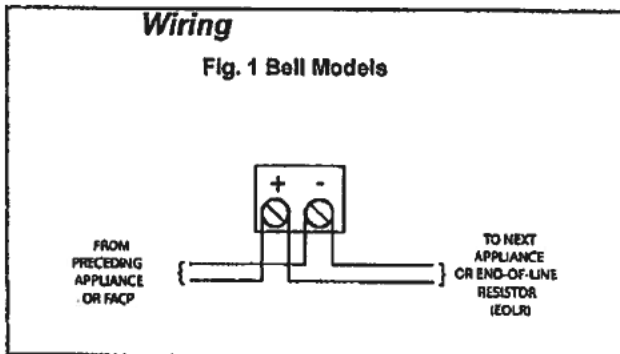

Wheelock products must be used within their published specification and must be properly specified, applied, installed, operated, maintained and operationally tested in accordance with their installation instruction at the time of installation and at least twice a year or more often and in accordance with local, state, and federal codes, regulations and laws. Specification, application, installation, operation, maintenance and testing must be performed by qualified personnel for proper operation in accordance with all of the latest National Fire Protection Association (NFPA), Underwriters' Laboratories (UL), local, state, county, province, district, federal and other applicable building and fire standards, guidelines, regulations, laws and codes including, but not limited to all appendices and amendments on the requirements of local authority having jurisdiction (AHJ).

Due to continuous development of our products, specifications and offering are subject to change without notice in accordance with Wheelock, Inc. standard terms and conditions.

⚠ WARNING: PLEASE READ THESE SPECIFICATIONS AND ASSOCIATED INSTALLATION INSTRUCTIONS CAREFULLY BEFORE USING, SPECIFYING OR APPLYING THIS PRODUCT. FAILURE TO COMPLY WITH ANY OF THESE INSTRUCTIONS, CAUTIONS OR WARNINGS COULD RESULT IN IMPROPER APPLICATION, INSTALLATION AND/OR OPERATION OF THESE PRODUCTS IN AN EMERGENCY SITUATION, WHICH COULD RESULT IN PROPERTY DAMAGE, AND SERIOUS INJURY OR DEATH TO YOU AND/OR OTHERS.



WE ENCOURAGE AND SUPPORT NICET CERTIFICATION
3 YEAR WARRANTY

S1600 MB 06/11

NJ Location
273 Branchport Ave.
Long Branch, NJ 07740
P: 800-631-2148
F: 732-222-8707
www.coopernotification.com

Cooper Notification is



COOPERNotification

TrueAlarm Analog Sensing Product Selection Chart

TrueAlarm Sensor Bases (for use with Sensors 4098-9714 and 4098-9733)

(Refer to Application Manual 574-709 and Installation Instructions 574-707 for additional information)

Model	Description	Compatibility	Mounting Requirements
4098-9792	Standard Sensor Base	No options	4" octagonal or 4" square box, 1-1/2" min. depth; or single gang box, 2" min. depth
4098-9789	Sensor Base with connections for Remote LED Alarm Indicator or Unsupervised Relay	2098-9808 Remote Alarm Indicator or 4098-9822 Unsupervised Relay	4" octagonal or 4" square box
4098-9791**	4-Wire Sensor Supervised Relay Base with connections for LED Indicator or Unsupervised Relay	2098-9737 Supervised Remote Relay 2098-9808 Remote Alarm Indicator or 4098-9822 Unsupervised Relay	Note: Box depth requirements depend on total wire count and wire size, refer to accessories list below for reference.
4098-9780**	2-Wire Sensor Supervised Relay Base with connections for LED Indicator or Unsupervised Relay	4098-9860 Supervised Remote Relay 2098-9808 Remote Alarm Indicator or 4098-9822 Unsupervised Relay	** NOTE: 4098-9791 and 4098-9780 are NOT compatible with the 2120 CDT

TrueAlarm Sensors

Model	Description	Compatibility	Mounting Requirements
4098-9714	Photoelectric Smoke Sensor	Bases 4098-9792, 4098-9789, 4098-9791, and 4098-9780	Refer to base requirements
4098-9733	Heat Sensor		

TrueAlarm Sensor/Base Accessories

Model	Description	Compatibility	Mounting Requirements
2098-9737	Supervised Relay, mounts remote or in base electrical box	For use with 4098-9791 base	Remote Mounting requires 4" octagonal or 4" square box, 1-1/2" minimum depth
4098-9860	Supervised Relay, mounts remote or in base electrical box	For use with 4098-9780 base	Base Mounting requires 4" octagonal box, 2-1/8" deep with 1-1/2" extension ring
2098-9808	Remote Red LED Alarm Indicator on single gang stainless steel plate	Bases 4098-9789, 4098-9791, and 4098-9780	Single gang box, 1-1/2" minimum depth
4098-9822	Unsupervised Relay, tracks base LED status; Note: Mounts only in base electrical box	Bases 4098-9789, 4098-9791, and 4098-9780	4" octagonal box, 2-1/8" deep with 1-1/2" extension ring
4098-9832	Adapter Plate	Bases 4098-9792, 4098-9789, 4098-9791, and 4098-9780	Required for surface or semi-flush mounted 4" square box and for surface mounted 4" octagonal box

Specifications

General Operating Specifications	
Communications and Sensor Supervisory Power	IDNet or MAPNET II communications, auto-selected, 1 address per base
Communications Connections	Screw terminals for In/Out wiring, 18 to 14 AWG (0.82 mm ² to 2.08 mm ²)
Remote LED Alarm Indicator Current	1 mA typical, no impact to alarm current
Remote LED Alarm Indicator and Relay Connections	Color coded wire leads, 18 AWG (0.82 mm ²)
UL Listed Operating Temperature Range	32° to 100° F (0° to 38° C)
Operating Temperature Range	with 4098-9733 Heat Sensor 32° to 122° F (0° to 50° C)
	with 4098-9714 Smoke Sensor 15° to 122° F (-9° to 50° C)
Storage Temperature Range	0° F to 140° F (-18° C to 60° C)
Humidity Range	10 to 95% RH
4098-9714 Smoke Sensor Air Velocity Rating	0-4000 ft/min (0-1220 m/min)
Housing Color	Frost White
4098-9791 Base With Supervised Remote Relay 2098-9737 (see page 2 for contact ratings)	
Externally Supplied Relay Coil Voltage	18-32 VDC (nominal 24 VDC)
Supervisory Current	270 µA, from 24 VDC supply
Alarm Current with 2098-9737 Relay	28 mA, from 24 VDC supply
4098-9780 Base With Supervised Remote Relay 4098-9860 (see page 2 for contact ratings)	
Power	Supplied from communications
4098-9822 Unsupervised Relay, Requirements for Bases 4098-9789, 4098-9791, and 4098-9780 (see page 2 for contact ratings)	
Externally Supplied Relay Coil Voltage	18-32 VDC (nominal 24 VDC)
Supervisory Current	Supplied from communications
Alarm Current	13 mA from separate 24 VDC supply

TYCO, SIMPLEX, and the product names listed in this material are marks and/or registered marks. Unauthorized use is strictly prohibited. NFPA 72 and National Fire Alarm and Signaling Code are trademarks of the National Fire Protection Association (NFPA).



Tyco Fire Protection Products • Westminster, MA • 01441-0001 • USA

S4098-0019-18 6/2014

www.simplex-fire.com

© 2014 Tyco Fire Protection Products. All rights reserved. All specifications and other information shown were current as of document revision date and are subject to change without notice.

Introduction

4100ES Series Fire Detection and Control Panels provide extensive installation, operator, and service features with point and module capacities suitable for a wide range of system applications. An on-board Ethernet port provides fast external system communications to expedite installation and service activity. Dedicated compact flash memory archiving provides secure on-site system information storage of electronic job configuration files to meet NFPA 72 (*National Fire Alarm and Signaling Code*) requirements.

Modular design. A wide variety of functional modules are available to meet specific system requirements. Selections allow panels to be configured for either Stand-Alone or Networked fire control operation.

Module Bay Description

The **Master Controller Bay** (top) includes a standard multi-featured enhanced power supply (EPS) with IDNet 2 Module, the master controller board, two vertical expansion blocks, and operator interface equipment.

The **Expansion Bays** include a Power Distribution Interface (PDI) for connection of single or multiple block modules, and/or slot style (motherboard/daughter card) modules.

The **Battery Compartment** (bottom) accepts two batteries, up to 50 Ah, to be mounted within the cabinet without interfering with module space.

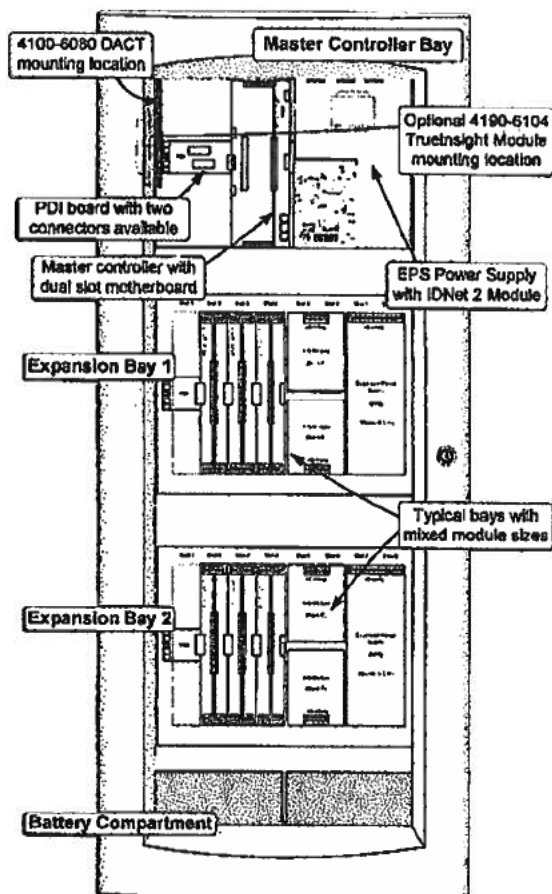

4100ES Module Placement Reference in 3-Bay Cabinet

Mechanical Description

- Boxes can be close-nipped; each box provides convenient stud markers for drywall thickness and nail-hole knockouts for quicker mounting
- Smooth box surfaces are provided for locally cutting conduit entrance holes exactly where required
- Cabinet assembly design has been seismic tested and is certified to IBC and CBC standards as well as to ASCE 7 categories A through F, requires battery brackets as detailed on data sheet S2081-0019
- The latching front panel assembly easily lifts off for internal access
- Modules are power-limited (except as noted, such as relay modules)
- The NEMA 1/IP30 box is ordered separately and available for early installation
- Doors are available with tempered glass inserts or solid; boxes and doors are available in platinum or red
- Boxes and door/retainer assemblies are ordered separately per system requirements; refer to data sheet S4100-0037

Operator Interface Detail Reference

The following illustration identifies the primary functions of the operator interface.

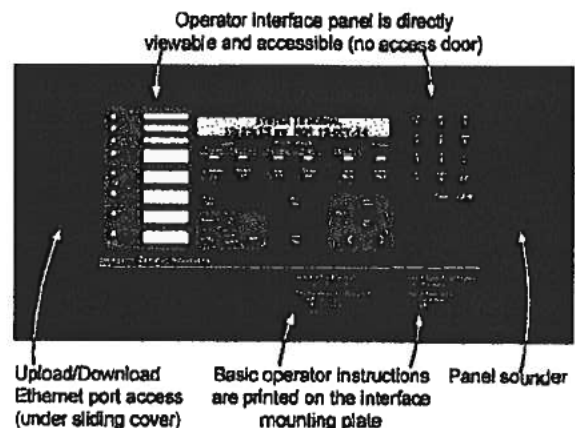

Software Feature Summary

- **"Install Mode"** allows grouping of multiple troubles for uninstalled modules and devices into a single trouble condition (typical with future phased expansion); with future equipment and devices grouped into a single trouble, operators can more clearly identify events from the commissioned and occupied areas
- Module level ground fault searching assists installation and service by locating and isolating modules with grounded wiring
- **"Recurring Trouble Filtering"** allows the panel to recognize, process, and log recurring intermittent troubles (such as external wiring ground faults), but only sends a single outbound system trouble to avoid nuisance communications
- WALKTEST silent or audible system test performs an automatic self-resetting test cycle
- Support for TrueAlarm individual analog sensing and IDNAC addressable notification with front panel information and selection access

Operator Interface

Convenient Status Information. With the locking door closed, the glass window allows viewing of the display, status LEDs, and available operator switches. Features include a two-line by 40-character, wide viewing angle (super-twist) LCD with status LEDs and switches as shown in the illustration below.

LED indicators describe the general category of activity being displayed with the LCD providing more detail. For the authorized user, unlocking the door provides access to the control switches and allows further inquiry by scrolling the display for additional detail.

Operator Interface Features

- Convenient and extensive operator information is provided using a logical, menu-driven display
- Multiple automatic and manual diagnostics for maintenance reduction
- Alarm and Trouble History Logs (up to 1250 entries for each, 2500 total events) are available for viewing from the LCD, or capable of being printed to a connected printer, or downloaded to a service computer
- Convenient PC programmer label editing
- Password access control

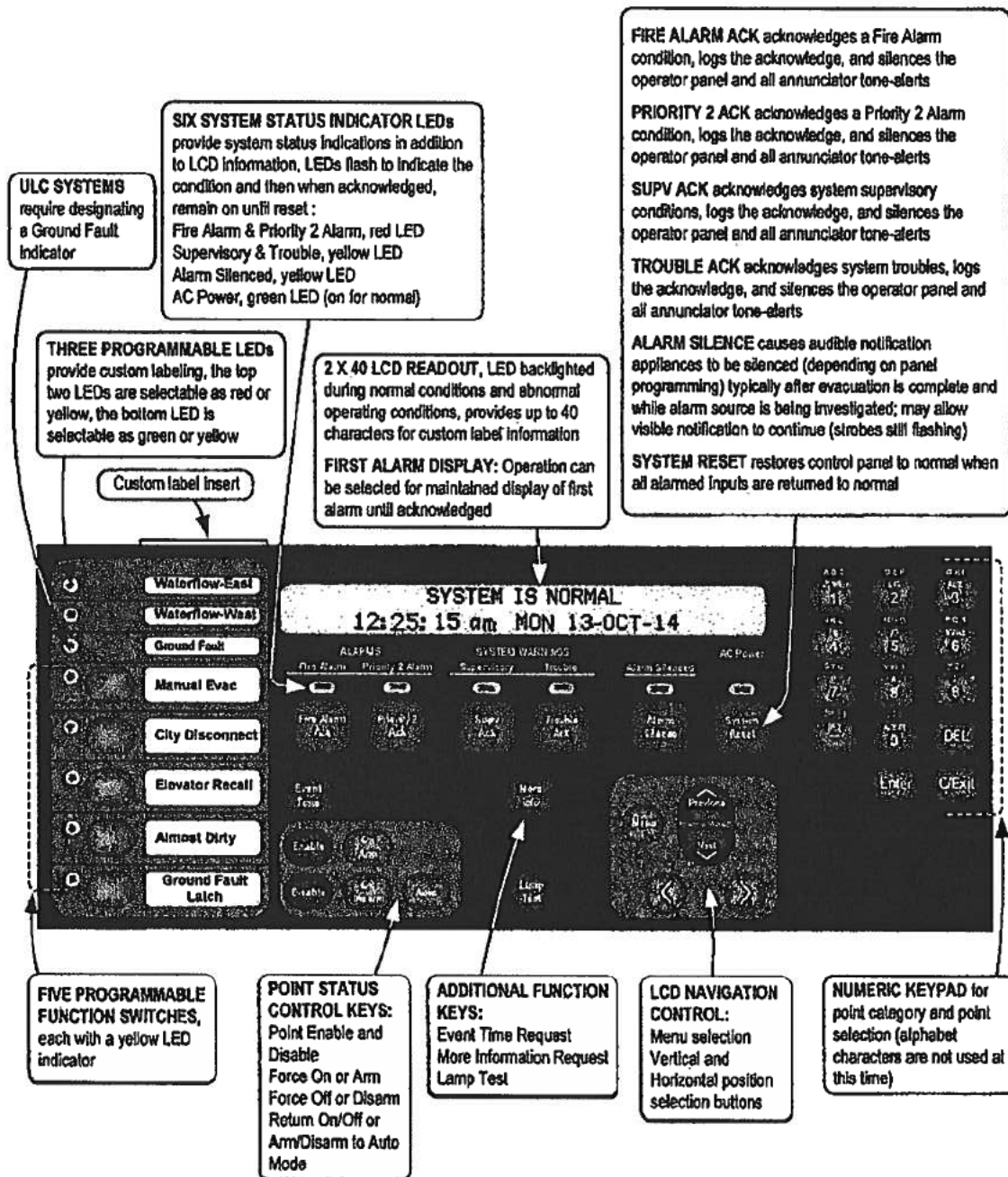

IDNet Addressable Device and IDNAC Addressable Notification Appliance Control

Overview. The 4100ES EPS power supply with IDNet 2 Module provides addressable initiating device and IDNAC addressable notification appliance Signaling Line Circuits (SLCs) that supervise wiring connections and the individual device/appliance communications status on their SLC. With these 2-wire SLCs, initiation, monitoring, and control devices such as manual fire alarm stations, TrueAlarm sensors, control relays, and sprinkler waterflow switches; and notification appliances such as strobes and horns can communicate their identity and status and receive fire alarm system control. Additional interface modules include circuit isolators, conventional IDC zone adapters, and interface to other system circuits such as fans, dampers, and elevator controls.

IDNet Addressable Device Operation

Each addressable device on an IDNet communication channel is continuously interrogated for status condition such as: normal, off-normal, alarm, supervisory, or trouble. Both Class B and Class A operation is available. Sophisticated poll and response communication techniques ensure supervision integrity and allow for "T-tapping" of the circuits for Class B operation. Devices with LEDs pulse the LED to indicate receipt of a communications poll and can be turned on steady from the panel. With addressable devices, the location and status of the connected device is monitored and logged, and displayed on the operator interface LCD and on remote system annunciators with each device having its own 40 character custom label for precise identification.

TrueAlarm Addressable Sensor Operation

Addressable initiating device communications include operation of TrueAlarm smoke and temperature sensors. Smoke sensors transmit an output value based on their smoke chamber condition and the CPU maintains a current value, peak value, and an average value for each sensor. Status is determined by comparing the current sensor value to its average value. Tracking this average value as a continuously shifting reference point filters out environmental factors that cause shifts in sensitivity.

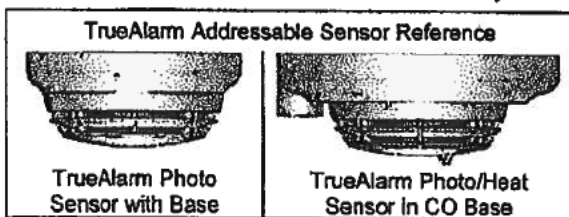

Programmable sensitivity of each sensor can be selected at the control panel for different levels of smoke obscuration (shown directly in percent) or for specific heat detection levels. To evaluate whether the sensitivity should be revised, the peak value is stored in memory and can be easily read (or downloaded as a report) and compared to the alarm threshold directly in percent.

CO sensor bases combine an electrolytic CO sensing module with a TrueAlarm analog sensor to provide a single multiple sensing assembly using one system address. The CO sensor can be enabled/disabled, used in LED/Switch modes and custom control, and can be made public for communication across a fire alarm Network. (refer to data sheet S4098-0052 for details)

TrueAlarm heat sensors can be selected for fixed temperature detection, with or without rate-of-rise detection. Utility temperature sensing is also available, typically to provide freeze warnings or alert to HVAC system problems. Readings can be selected as either Fahrenheit or Celsius.

TrueSense Early Fire Detection. Multi-sensor 4098-9754 provides photoelectric and heat sensor data using a single 4100ES IDNet address. The panel evaluates smoke activity, heat activity, and their combination, to provide TrueSense early detection. For more details on this operation, refer to data sheet S4098-0024.

Diagnostics and Default Device Type

Sensor Status. TrueAlarm operation allows the control panel to automatically indicate when a sensor is almost dirty, dirty, and excessively dirty. The NFPA 72 requirement for a test of the sensitivity range of the sensors is fulfilled by the ability of TrueAlarm operation to maintain the sensitivity level of each sensor. CO Sensors track their 10 year active life status providing indicators to assist with service planning. Indicators occur at: 1 year, 6 months, and end of life.

Modular TrueAlarm sensors use the same base and different sensor types (smoke or heat sensor) and can be easily interchanged to meet specific location requirements. This allows intentional sensor substitution during building construction when conditions are temporarily dusty. Instead of covering smoke sensors (causing them to be disabled), heat sensors may be installed without reprogramming the control panel. The control panel will indicate an incorrect sensor type, but the heat sensor will operate at a default sensitivity to provide heat detection for building protection at that location.

IDNet Addressable Device Wiring Reference

IDNet Addressable Channel Capacity. The CPU bay standard power supply (EPS) provides an IDNet 2 Module providing a signaling line circuit (SLC) that supports up to 250 addressable monitor and control points intermixed on the same pair of wires. IDNet 2 and IDNet 2+2 Module SLCs are isolated from other system reference voltages to reduce common mode noise interaction with adjacent system wiring. Additional 250 address IDNet 2 or IDNet 2+2 Modules are available.

IDNet 2 and IDNet 2+2 SLC Wiring Specifications

Maximum Distance from Control Panel	1 to 125	4000 ft (1219 m); 50 ohms
per Device Load	126-250	2500 feet (762 m); 35 ohms
Total Wire Length Allowed With "T" Taps for Class B Wiring		Up to 12,500 ft (3.8 km); 0.60 μ F
Maximum Capacitance Between IDNet 2 Channels		1 μ F
Wire Type and Connections		Shielded or unshielded, twisted or untwisted wire*
Connections		Terminals for 18 to 12 AWG (0.82 mm ² to 3.31 mm ²)

IDNet 2 and IDNet 2+2 Module Compatibility: IDNet communicating devices and TrueAlarm sensors including QuickConnect and QuickConnect2 sensors

* Some applications may require shielded wiring. Review your system with your local Simplex product supplier.

IDNAC SLC Control of TrueAlert and TrueAlert ES Addressable Notification

Addressable notification appliance communications include operation of TrueAlert and TrueAlert ES Visible only (V/O, strobe), Audible only (A/O, horn), Audible/Visible (A/V, horn/strobe), and strobes of Speaker/Visible (S/V) notification appliances. (S/V appliances require separate speaker wiring.) IDNAC SLC addressable communications allow each horn and strobe to be individually controlled using a single two-wire circuit, confirms the wiring connections to the individual notification appliance's electronic circuit, and confirms communications between each appliance and the fire alarm control panel. Addressable communications increases supervision integrity versus conventional notification systems by providing supervision beyond the circuit wiring to each individual appliance and by constantly verifying the ability of each appliance to communicate with the control panel.

Individual Appliance Status and Settings. The fire alarm control panel monitors and records each addressable notification appliance status, type of appliance, and its configured appliance settings. A fault in any individual appliance automatically reports a trouble condition to the control panel.

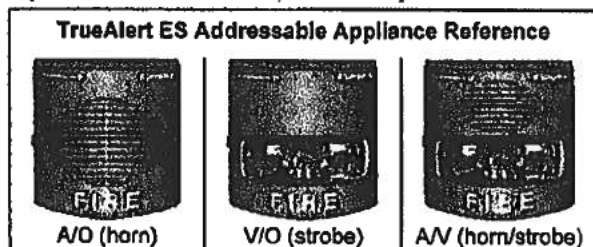

Virtual NACs Provide Control Convenience. For control convenience, IDNAC notification appliances can be grouped into *Virtual NACs* (VNACs) for group control, grouping that can be made across SLCs, not defined by their wiring connection.

Panel Control Convenience. Applicable operation settings for each appliance can be programmed *without having to replace appliances or remove them from the wall or ceiling*. An appliance's VNAC notification zone can be easily changed through programming without having to add additional circuits, conduit, and wiring. Audible and visible appliances for non-Fire Emergency Communications notification can be programmed to operate separately *on the same pair of wires as the fire alarm notification appliances*. The result is lower installation, retrofit, and overall life-cycle cost of ownership compared with traditional conventional notification systems.

Installation, Retrofit, and Life-Cycle Cost Benefits.

With each addressable appliance capable of being controlled separately on the same two-wire IDNAC SLC, installation time and expense for both retrofit and new construction can be significantly reduced. When Class B wiring is used, wiring can be "T-tapped" allowing more savings in distance, wire, conduit (size and utilization), and overall installation efficiency.

Location Information, Diagnostics and

Troubleshooting. Each addressable notification appliance has its own 40 character custom label to identify the location of the appliance and to aid in troubleshooting fault conditions. In conventional notification systems, conventional appliances are not capable of communicating with the control panel. Fault reporting on a conventional system is limited to the circuit wiring and the entire area (zone) covered by appliances on the notification appliance circuit (NAC) making it much more difficult and costly to locate and correct the source of a

problem. Using the TrueAlert *magnet test* allows each appliance to individually identify its candela setting and address and to briefly operate if desired, and using the *TrueAlert ES Appliance Self-Test feature provides detailed performance verification per appliance*.

TrueAlert ES Appliance Self-Test Operation

On-Board Test Sensors. TrueAlert ES appliances are equipped with on-board sensors to detect strobe and/or horn output allowing efficient and unobtrusive Self-Testing. When Automatic Self-Test is initiated from the control panel, each appliance within the selected VNAC group will briefly operate and then report its Self-Test status to the control panel, all within several seconds. Silent Self-Test can be selected to test only visible appliance if desired. The control panel is in a trouble condition during testing and in the event of an alarm, Self-Test is automatically terminated. Additionally, Automatic Self-Test can be scheduled to occur at a convenient time on a regular basis. (Requires version 2.03.01 or higher software.)

Automatic Self-Test results are communicated to the control panel with a time and date stamp and are stored in memory. Results are viewable at the front panel display and printed reports can be generated from the panel service port. (See sample reports on page 11.)

Individual Self-Test is selected from the control panel when individual appliances need to be observed to operate. Each appliance in the selected VNAC group will turn on its LED until individually activated by applying a magnet. After performing the individual test, the appliance LED turns off to indicate completion. Results are recorded the same as during the automatic test.

IDNAC SLC Hardware Reference

EPS Power Supplies provide three, 3 A IDNAC SLCs for control and power to TrueAlert ES and TrueAlert addressable notification appliances. Both power supplies incorporate an efficient switching design that provides a regulated output of 29 VRMS, even during battery operation. With 29 VRMS minimum output at the panel, addressable notification SLCs can support wiring distances 2 to 3 times farther than available with conventional notification, or support more appliances per SLC, or work with smaller gauge wiring, or combinations of these benefits, all resulting in installation and maintenance savings with high assurance appliances that operate during normal system testing will operate during worst case alarm conditions.

IDNAC SLC Appliance Wiring Reference

IDNAC SLC Capacity: Up to 63 addresses and up to 75 unit loads (appliances are typically one unit load, devices such as Isolators may require more than one load, refer to individual device data sheet for specific information)

Recommended wire type	UTP, unshielded twisted pair
Maximum wire length allowed with "T-Taps" for Class B wiring, per SLC	10,000 ft (3048 m)
Maximum wire length per SLC to any appliance	4000 ft (1219 m)
Maximum wiring resistance between appliances	26 Ω
Wiring connections	Terminals for 18 to 12 AWG (0.82 mm ² to 3.31 mm ²)
Installation Instructions (see for more information)	579-1015

Standard CPU Bay Module Details

Master Controller and Motherboard:

- Mounts in Slot 2 of a two slot motherboard and provides one Class B or Class A, RUI+ isolated communications channel with earth fault detection
- RUI+ isolated communications controls up to 31 remote devices per master controller at up to 2500 ft (762 m) for single run, or 10,000 ft (3048 m) total if wiring is Class B and T-tapped; if more distance is required, up to four total RUI channels are supported; add up to three 4100-1291 RUI Expansion Modules (4100-1291 provides unisolated RUI communications)
- Compatible RUI+ remote equipment includes: MINIPLEX transponders, 4603-9101 LCD Annunciators, and 4100 Series 24 I/O and LED/Switch modules
- RUI Expansion Module 4100-1291 is also compatible with the RUI+ remote equipment listed above; and is required for control of 4602 Series LED/Switch and I/O Annunciator modules, including 4602-9101 Status Command Units (SCU), and 4602-9102 Remote Command Units (RCU); (refer to data sheet S4602-0001)
- Open slot space on the left of the CPU motherboard is available for either another dual slot motherboard, or for one or two block modules (refer to diagram on page 2)
- Slot 1 of the motherboard is primarily for the 4100-6078 Network Interface Board with media modules

EPS (Enhanced Power Supply) with IDNet 2 Module Details: (see page 9 for specifications)

- Rating is 9 A total with "Special Application" appliances
- Outputs are power-limited, except for the battery charger
- Provides system power, battery charging, auxiliary power, earth detection, on-board IDNet 2 Module with 250 point SLC, three on-board 3 A IDNAC SLCs, and provisions for either an optional City Connect Module or an optional Alarm Relay Module
- IDNet 2 Module SLC Output provides Class B or Class A communications for up to 250 addressable devices with dual short circuit isolating loop outputs (see details on page 4)
- Note: The "IDNet 2 Module" replaced the "IDNet 1+ Module" and the term "EPS with IDNet 2 Module" replaces the term "EPS+"

EPS with IDNet 2 Module Details (Continued):

- DCAI (Dual Class A IDNAC Isolator) Module creates two Class A outputs from one IDNAC SLC Class B Input; up to two can be connected to one IDNAC SLC, with up to 6 total per EPS; total Class A output loop current is limited to the 3 A rating of the IDNAC SLC
- Battery Charger is dual rate, temperature compensated, and charges up to 50 Ah sealed lead-acid batteries mounted in the battery compartment (33 Ah for single bay cabinets); also is UL listed for charging up to 115 Ah batteries mounted in an external cabinet (see data sheet S2081-0012 for details)
- Battery and Charger Monitoring includes battery charger status and low or depleted battery conditions; status information provided to the master controller includes analog values for: battery voltage, charger voltage and current, actual system voltage and current, and individual IDNAC SLC currents
- Low Battery Cutout is selectable for each EPS power supply, Canadian models are shipped selected, other models are shipped unselected

2 A Programmable Output:

- Select for conventional non-synchronous NAC operation to provide supervised reverse polarity for sounder base power, Suppression Release Peripheral (SRP) power, or other coded NAC operation requirements
- Select for Auxiliary (AUX) operation for sounder base power, 4-wire detector power, or door holder; supervised AUX operation does not require an end-of-line relay to provide Power-Limited operation

EPS Mounted Optional Modules (select one):

- City Connect Module (4100-6031, with disconnect switches, or 4100-6032, without disconnect switches) can be selected for conventional dual circuit city connections
- Alarm Relay Module (4100-6033) provides three Form C relays that are used for Alarm, Trouble, and Supervisory, rated 2 A resistive @ 32 VDC

Master Controller Selection Information

Master Controller and Expansion Bay Selection

Model	Model Type and Listing	Description	Current
4100-9311	120 VAC, 50/60 Hz Input	4100ES Master Controller Assembly with LCD and operator interface, 9 A EPS (Enhanced Power Supply/battery charger) with 250 point IDNet 2 Module, 3 Class B IDNAC SLCs, RUI+ isolated output communications interface, and one output configurable for Auxiliary or simple NAC operation	Without IDNet devices: Supervisory = 425 mA Alarm = 735 mA
4100-9312	English		
4100-9313	French Canadian		
4100-9511	220-240 VAC, 50/60 Hz Input	UL	With 250 IDNet devices and 20 device LEDs in alarm: Supervisory = 625 mA Alarm = 1025 mA
4100-9331	120 VAC, 50/60 Hz input	UL	
4100-9332	120 VAC, 50/60 Hz input, Canadian, English	ULC	
4100-2300	Expansion Bay Assembly, order for each required expansion bay		
4100-2303	Slot Module Stabilizer Bracket, used when expansion bays have style modules		

(Continued on next page)

Module Selection Information

Communication Modules

Model	Description	Size	Supv.	Alarm	
4100-6078	For Master Controller, mounts in Slot 3	Modular Network Interface; each requires two media modules (below)	1 Slot	46 mA	46 mA
4100-6061	For Redundant Master Controller		1 Slot	46 mA	46 mA
4100-6056	Wired Media Module	Select two media cards as required; mounts on	N.A.	55 mA	55 mA
4100-6057	Fiber Optic Media Module	4100-6078 or 4100-6061; Class B or Class X operation	N.A.	25 mA	25 mA
4100-6047	Building Network Interface Card (BNIC), refer to data sheet S4100-0061 for details		2 Blocks	291 mA	291 mA
4100-6055	Network Access Dial-in Service Modem, mounts to 4100-6078 or 4100-6061 Network Interface Card, requires telephone line connection		N.A.	60 mA	60 mA
4100-1291	Remote Unit Interface Module (RUI, unisolated); up to 3 maximum per control panel		1 Slot	85 mA	85 mA
4100-6031	Select one per EPS	City Circuit, with disconnect switches	N.A.	20 mA	36 mA
4100-6032		City Circuit, w/o disconnect switches	N.A.	20 mA	36 mA
4100-6033		Alarm Relay, 3 Form C relays, 2 A @ 32 VDC	N.A.	15 mA	37 mA
4100-6048	Dual Port RS-232 standard interface (single block)	3 maximum RS-232 Modules per panel	1 Block	60 mA	60 mA
4100-6038	Dual Port RS-232 with 2120 interface (slot module)		1 Slot	132 mA	132 mA
4100-6079	SafeLINC Internet Interface (refer to data sheet S4100-0062 for details)		2 Blocks	145 mA	145 mA
4190-6104	TrueInsight Remote Monitoring Module (refer to data sheet S4100-0063 for details)		Side Mt.	62 mA	73 mA
4100-6101	Physical Bridge, Class B, includes 1 modem module and 2 wired modules		1 Slot	210 mA	210 mA
4100-6102	Physical Bridge, Class X, includes 2 modem and 2 wired modules		2 Slots	300 mA	300 mA
4100-6048	VESDA Aspiration System Interface (refer to data sheet S4100-0026 for details)		1 Slot	132 mA	132 mA
4100-6080	DACT, Point or Event Reporting; 1 shipped unless 4100-7908 is selected; 2 max. per system; includes 2, 2080-9047 cables, 14 ft (4.3 m) long, RJ45 plug and spade lugs		Side Mt.	30 mA	40 mA

Additional Enhanced Power Supplies, Expansion Power Supply, and Accessories (for additional non-addressable Power Supplies, refer to data sheet S4100-0031)

Model	Voltage/Listing	Description	Size	Supv.	Alarm	
4100-5311	120 VAC	Expansion EPS with IDNet 2 Module; 9 A Enhanced Power Supply/battery charger with 250 point IDNet 2 Module, 3 Class B IDNAC SLCs, and RUI+ isolated output communications interface; 120 VAC model has selectable low battery cutout	4 Blocks Right Side	225 mA	490 mA	
4100-5313	220-240 VAC					UL
4100-5325	120 VAC	Expansion EPS (without IDNet 2 Module); 9 A Enhanced Power Supply/battery charger with 3 Class B IDNAC SLCs, and RUI+ isolated output communications interface; 120 VAC model has selectable low battery cutout	4 Blocks Right Side	125 mA	220 mA	
4100-5327	220-240 VAC					UL
4100-5101	120 VAC	Expansion Power Supply (XPS); 9 A output, 3 built-in Class A/B conventional (non-addressable) 3 A NACs that can also be selected as 2 A auxiliary power output, 2 A separate auxiliary power output; without battery charger; Canadian model has low battery cutout	2 Blocks	50 mA	50 mA	
4100-5103	120 VAC, Canadian					ULC
4100-5102	220-240 VAC					UL
4100-5115	NAC Expansion Module, 3 NACs, Class A/B, mounts on XPS only		N.A.	25 mA	25 mA	
4100-6103	Dual Class A IDNAC Isolator (DCAI), converts a single Class B IDNAC SLC input to two Class A or two Class B SLC outputs; provides short circuit isolation between each Class A or B output circuit; connect up to two DCAI Modules per IDNAC SLC input up to a maximum of 8 DCAI Modules per EPS; each isolated output SLC used requires one IDNAC address; the total current remains controlled by the Class B input source SLC at 3 A maximum		1 Block	8.3 mA	18.5 mA	
4100-5152	12 VDC Power Option, 2 A maximum		1 Block	1.5 A maximum		
4100-0156	8 VDC Converter, required for multiple Physical Bridge Modules, 3 A maximum		1 Block	included w/loads		
4100-0636	Box Interconnection Harness Kit (non-audio); order one for each close-nipped cabinet					
4100-0638	4100 Slot Module Additional 24 VDC Harness; need when 4100 Slot module requirements exceed 2 A from EPS					

Module Selection is continued on next page

Module Selection Information (Continued)

Addressable Interface Modules (Note: Total of Initiating SLCs per CPU, including VESDA Interface, is 30)

Model	Description		Supv.	Alarm
4100-3109*	IDNet 2 Module, 250 point capacity; electrically isolated output with two short circuit isolating Class B or Class A output loops, 1 block; standard on EPS with IDNet 2 Module; alarm currents for 50 and above devices includes 20 device LEDs in alarm	no devices	50 mA	60 mA
		50 devices	90 mA	150 mA
		125 devices	150 mA	225 mA
		250 devices	250 mA	350 mA
4100-3110*	IDNet 2+2 Module, 250 point capacity; electrically isolated output with four short circuit isolating Class B or Class A output loops, 1 block; mounts in expansion bay or available master controller bay module locations only, not applicable for EPS mounting; alarm currents for 50 and above devices includes 20 device LEDs in alarm	no devices	50 mA	60 mA
		50 devices	90 mA	150 mA
		125 devices	150 mA	225 mA
		250 devices	250 mA	350 mA
4100-3111*	IDNet Short Circuit Isolating Loop Output Module; mount up to two on a 4100-3109 module; for use with 4100-3109 modules in expansion bays or available master controller bay module locations only; not applicable for mounting on a 4100-3109 mounted on an EPS; this option is for aftermarket field installation only			
4100-3112	Four Loop IDNet Master Controller; for the Master Controller Assemblies listed on page 6, this option moves the standard IDNet 2 Module from the Master Controller EPS to an available block space in the master controller bay and adds 2, 4100-3111 IDNet Loop Output Modules; requires selection of Factory Built Option 4100-7905; current requirements remain the same			

*Note: Loading per IDNet device (no LEDs on) = 0.8 mA supervisory and 1 mA alarm.

Each IDNet 2 and IDNet 2+2 Short Circuit Isolating Loop Output can be individually controlled for system diagnostics and can be assigned a public point for Fire Alarm Network annunciation.

Relay Modules; Nonpower-limited (for mounting in expansion bay only, refer to location reference on page 10)

Model	Description	Resistive Ratings	Inductive Ratings	Size	Supv.	Alarm
4100-3202	4 DPDT w/feedback	10 A @ 250 VAC	10 A @ 250 VAC	2 Slots	15 mA	175 mA
4100-3204	4 DPDT w/feedback	2 A @ 30 VDC/VAC	1/2 A @ 30 VDC/120 VAC	1 Block	15 mA	60 mA
4100-3206	8 SPDT	3 A @ 30 VDC/120 VAC	1-1/2 A @ 30 VDC/120 VAC	1 Block	15 mA	190 mA

Current Calculation Notes:

- To determine total supervisory current, add currents of modules in panel to base system value and all external loads powered by panel power supplies.
- To determine total alarm current, add currents of modules in panel to base system alarm current and add all panel SLC and NAC loads and all external loads powered from panel power supplies.

End User Programming Software (requires 4100-8802)

Model	Description
4100-8802	Programming Software (select)

End User Programming Software Selection (select maximum of one each from below)

Model	Description
4100-0282	Custom Labels Editing; allows editing of 40 Character Custom Labels for non-system user points
4100-0296	Access Level/Passcode Editing; allows user to re-assign Access Levels and Passcodes for each display function; Acknowledge, Alarm Silence, System Reset, Point Enable/Disable, WALKTEST Enable/Disable, Clear History Logs, Change Time & Date, etc.
4100-0285	Port Vectoring Setup and Control; Allows vectoring of events to PC Annunciator, Printers, LCD Annunciators, etc.
4100-0298	WALKTEST Configuration Setup and Control; Allows user to create or edit WALKTEST groups used to test system initiating devices and signals by a single person, these groups allow an inspector to conduct a one-person WALKTEST in a specific area of a building (or different buildings), and limit the activation of the building signals to only the intended area; up to 8 WALKTEST groups are supported

Miscellaneous Accessories

Model	Description
4100-1279	Single blank 2" display cover; 4100-2302 provides a single plate for a full bay
4100-9835	Termination and Address Label Kit (for module marking); provides additional labels for field installed modules
4100-8028	Smoke Management Application Guide; required for UUKL listing
4100-6034	Tamper Switch, one per cabinet assembly if required; monitors solid door for panels with solid door; monitors the internal retainer panel for panels with glass door (not the glass door); has a built-in addressable IDNet IAM
2081-9031	Series resistor for WSO, IDCs (N.O. water flow and tamper on same circuit, wires after water flow and before tamper) 470 Ω, 1 W, encapsulated, two 18 AWG leads (0.82 mm ²), 2-1/2" L x 1-3/8" W x 1" H (64 mm x 35 mm x 25 mm)

General Specifications

Input Power	Enhanced Power Supplies (EPS)	120 VAC Models	4.6 A maximum @ 102 to 132 VAC, 50/60 Hz	
		220-240 VAC Models	2.3 A maximum @ 204 to 264 VAC, 50/60 Hz; separate taps for 220/230/240 VAC	
	Expansion Power Supplies (XPS)	120 VAC Models	4 A maximum @ 102 to 132 VAC, 60 Hz	
		220-240 VAC Models	2 A maximum @ 204 to 264 VAC, 50/60 Hz; separate taps for 220/230/240 VAC	
Power Supply Output Ratings for EPS	Total Power Supply Output Rating	Including module currents and auxiliary power outputs; 9 A total for "Special Application" appliances		Output switches to battery backup during mains AC failure or brownout conditions
	IDNAC SLC Ratings	3 A, regulated 29 VRMS, 63 addresses, 75 unit loads		
	IDNAC SLC Wiring	Output terminals are rated for 18 to 12 AWG with duplicate output terminals rated for two wires each, allowing up to four (4) Class B branch circuit T-taps to be made in the cabinet; additional T-taps may be made in external wiring junction cabinets or boxes		
	Auxiliary Power Tap	2 A maximum, 24 VDC nominal (19.5 to 31.1 VDC)		
Compatible Special Application Appliances		Simplex TrueAlert ES and TrueAlert addressable notification appliances; contact your Simplex product representative for compatible appliances		
Battery Charger Ratings for EPS (sealed lead-acid batteries)	Battery capacity range	UL listed for battery charging of 6.2 Ah up to 115 Ah (batteries larger than 50 Ah require a remote battery cabinet); ULC listed for charging up to 50 Ah batteries		
	Charger characteristics and performance	Temperature compensated, dual rate, recharges depleted batteries within 48 hours per UL Standard 864; to 70% capacity in 12 hours per ULC Standard S527		
Power Supply Output Ratings for XPS (nominal 28 VDC on AC; 24 VDC on battery backup)	Total Power Supply Output Rating	Including module currents and auxiliary power outputs; NAC outputs are rated 9 A total for "Special Application" non-addressable appliances; 4 A total for "Regulated 24 DC" power (see details below); 6 A total with each NAC selected as auxiliary power output		Output switches to battery backup during mains AC failure or brownout conditions
	Auxiliary Power Tap	2 A maximum		
	NACs Programmed for Auxiliary Power	2 A maximum per NAC; 5 A maximum total	Rated 19.1 to 31.1 VDC	
Special Application Appliances	Simplex horns, strobes, and combination horn/strobes and speaker/strobes (contact your Simplex product representative for compatible appliances)			
Regulated 24 DC Appliances	Power for other UL listed appliances; use associated external synchronization modules where required			
Environmental	Operating Temperature	32° to 120°F (0° to 49° C)		
	Operating Humidity	Up to 93% RH, non-condensing @ 90° F (32° C) maximum		
Additional Technical Reference				
Description	Document	Description	Document	
ES Installation Instructions	574-848	IDNet 2 and 2+2 Module Installation Instructions	579-1069	
ES Operating Instructions	578-197	EPS Installation Instructions	579-1015	
DCAI Module Installation Instructions	579-1029			

Additional 4100ES Data Sheet and Related Product Reference

Subject	Data Sheet	Subject	Data Sheet
Introducing the 4100ES	S4100-0060	Fire Alarm Network Overview	S4100-0055
4100ES Enclosures	S4100-0037	Network Communications	S4100-0056
4100ES Audio and Firefighter Phone Modules	S4100-0034	Network Display Unit (NDU)	S4100-0102
LED/Switch Modules & Printer	S4100-0032	Addressable Device Compatibility	S4090-0011
Remote Annunciators	S4100-0038	4008 IDNAC Repeater	S4009-0004
MINIPLEX Transponders	S4100-0103	Remote Battery Charger	S4081-0002
Building Network Interface (BNIC)	S4100-0081	SafeLINC Internet Interface	S4100-0082
InfoAlarm Command Center	S4100-0101	4100ES Panels for Conventional Notification	S4100-0031
Graphic I/O Modules	S4100-0005	TrueAlarm Sensors	S4098-0019
TrueInsight Remote Service	S4100-0063	Remote IDNet Isolator	S4090-0005
Agent Release Applications	S4100-0040	TrueAlarm IDNet Isolator Base	S4098-0025
TrueAlert ES Audible Only Appliances	S49AO-0001	TrueAlert ES Weatherproof Appliances, UL Listed	S49WP-0001
TrueAlert ES Visible Only Appliances	S49VO-0001	TrueAlert ES Weatherproof Appliances, ULC Listed	S49WP-0002
TrueAlert Appliance/IDNAC SLC Isolator	S4905-0001	TrueAlert ES Emergency Communications Appliances with Color Lenses	S49LENS-0001
TrueAlert ES Audible/Visible Appliances	S49AV-0001		

Expansion Bay Module Loading Reference

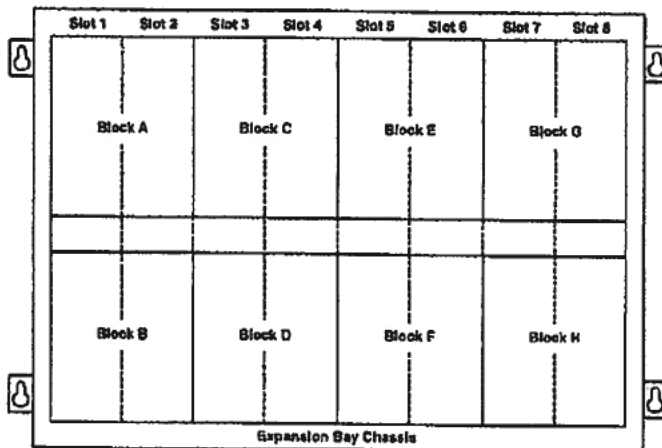

Size Definitions:

1 **Block** = 4" W x 5.65" H (102 mm x 144 mm); (often called 4 x 5 modules)

1 **Slot** = 2" W x 11.3" H (51 mm x 287 mm), typically a motherboard with daughter card

Mounting and CPU Bay Module Reference (* indicates supplied modules)

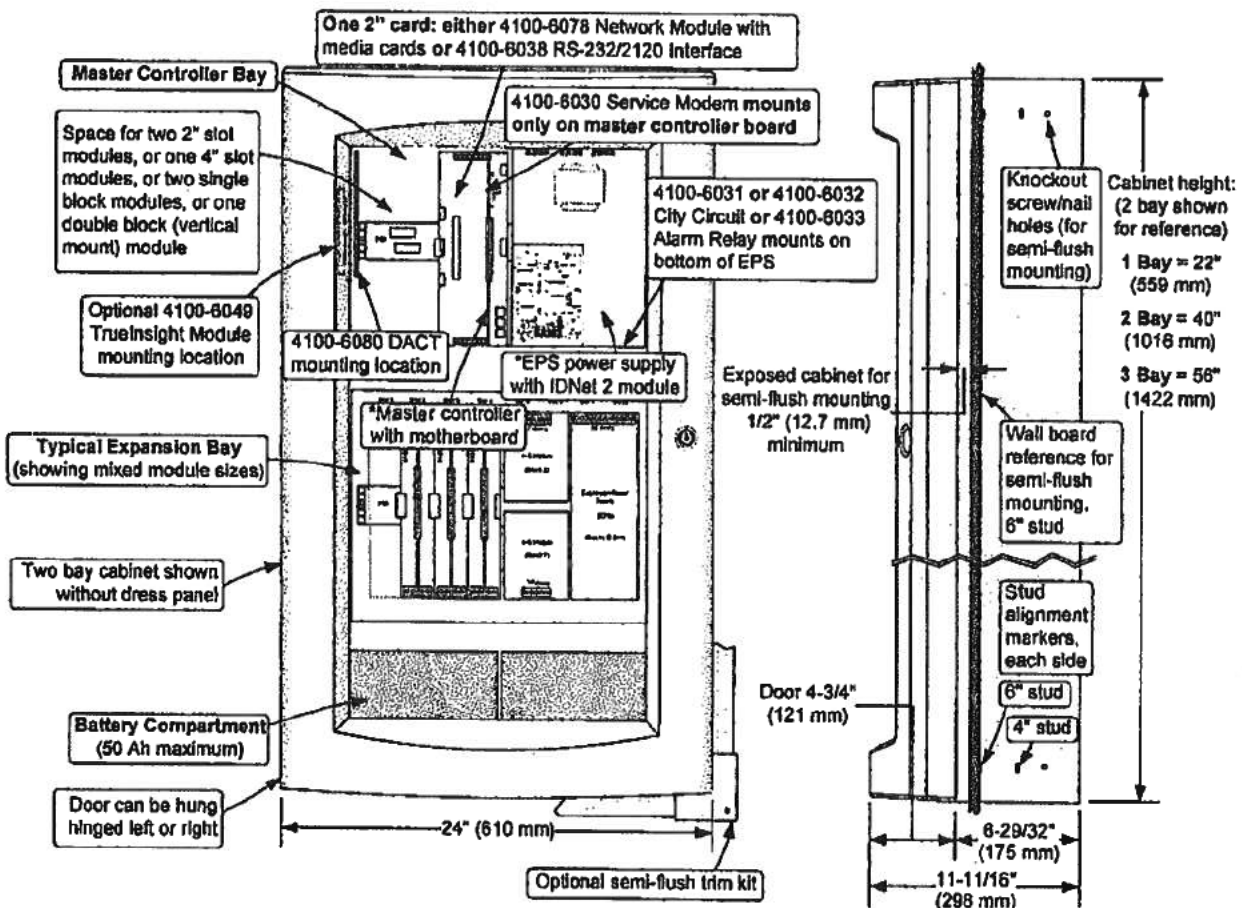

NOTE: A system ground must be provided for Earth Detection and transient protection devices. This connection shall be made to an approved, dedicated Earth connection per NFPA 70, Article 250, and NFPA 780.

TrueAlert ES Appliance Self-Test Last Test Results Report Example

Service Port				Page 1	
REPORT 10 TrueAlertES Self-Test Report			12:34:56pm MON 13-OCT-14		
Point ID	Custom Label	Date	Visual	Audible	
T1-1-1	VO FIRST FLOOR (up to 40 characters)	13-OCT-14	NO OUT	N/A	
T1-2-5	AV FIRST FLOOR EAST WING	13-OCT-14	NO OUT	NORMAL	
T7-3-55	AO SECOND FLOOR EAST WING	13-OCT-14	N/A	NO OUT	
T8-2-45	AV SECOND FLOOR ROOM 29	13-OCT-14	NOT TST	N/A	
T8-2-60	AV SECOND FLOOR ROOM 22	13-OCT-14	NORMAL	NORMAL	
T1-2-4	AO FIRST FLOOR ROOM 17	13-OCT-14	N/A	UNSUPP	
TRUEALERT_ES SELF-TEST REPORT COMPLETED					
Press RETURN for next Screen OR CTRL-X to abort					

Results Description:

NORMAL = works correctly

NO OUT = No Output, no light or sound was detected

NOT TST = no result; either the appliance did not return a result before the test ended or the test was conducted as silent (strokes only) and audible appliance was not activated

N/A = not applicable (no strobe on audible only, etc.)

UNSUPP = appliance not compatible with Self-Test (TrueAlert addressable appliance not TrueAlert ES addressable appliance)

Note: Additional TrueAlert ES Self-Test Information is detailed in ES Operating Instructions 579-197 shipped with the panel.

TrueAlert ES Appliance Self-Test All Test Results Report Example

Service Port				Page 1	
REPORT 10 TrueAlertES Self-Test Report			12:34:56pm MON 13-OCT-14		
Point ID	Custom Label	Date	Visual	Audible	
T1-1-1	VO FIRST FLOOR	13-OCT-14	NO OUT	N/A	
T1-2-5	AV FIRST FLOOR EAST WING	13-OCT-14	NO OUT	NORMAL	
T1-2-6	AV FIRST FLOOR NORTH ENTRANCE	30-MAY-14	NO OUT	NORMAL	
T7-3-55	AO SECOND FLOOR EAST WING	13-OCT-14	N/A	NO OUT	
T8-2-45	AV SECOND FLOOR ROOM 29	13-OCT-14	NOT TST	N/A	
T1-1-11	AV FIRST FLOOR SOUTH ENTRANCE	30-MAY-14	NORMAL	NORMAL	
T8-2-60	AV SECOND FLOOR ROOM 22	13-OCT-14	NORMAL	NORMAL	
T1-2-4	AO FIRST FLOOR ROOM 17	13-OCT-14	N/A	UNSUPP	
T1-2-7	AO FIRST FLOOR ROOM 12	30-MAY-14	N/A	UNSUPP	
T8-3-43	AV SECOND FLOOR ROOM 25	30-MAY-14	UNSUPP	UNSUPP	
TRUEALERT_ES SELF-TEST REPORT COMPLETED					
Press RETURN for next Screen OR CTRL-X to abort					

TrueAlert ES Appliance Self-Test Individual Appliance Report Example

CUSTOM LABEL	
4-1-2	AV
POINT ADDRESS: 4-1-2	Type: AV
CARD: 4 CHANNEL: 1 DEVICE: 2	
EXTENDED POWER SUPPLY	
UNIT NUMBER: 2	RUI NUMBER: LOCAL
PRIMARY STATUS	NORMAL
AUDIBLE GROUP CONFIG:	0 0 0
VISUAL GROUP CONFIG:	0 0 0
STYLE:	INDOOR
OPERATION:	GENERAL EVAC
CANDELA RATING	15 CD
COLOR LENS	YES
STONE TYPE	BROADBAND
CODING TYPE	TEMPORAL
VOLUME	HIGH
LAST TEST TIME:	MON 02-JUN-14 01:00 AM
LAST VISUAL TEST:	NORMAL
LAST AUDIBLE TEST:	NORMAL
LAST TEST VOLUME:	NORMAL
DEVICE TEST TROUBLE:	NORMAL

CALIFORNIA DEPARTMENT OF FORESTRY & FIRE PROTECTION
OFFICE OF THE STATE FIRE MARSHAL
FIRE ENGINEERING - BUILDING MATERIALS LISTING PROGRAM



LISTING SERVICE

LISTING No. 7165-0026:0251

Page 1 of 4

CATEGORY: 7165 – FIRE ALARM CONTROL UNIT (COMMERCIAL)

LISTEE: Simplex100 Simplex Drive, Westminster, MA 01441-0001
Contact: Jim Goyette (978) 731-8580 Fax (978) 731-8881
Email: james.goyette@jcl.com

DESIGN: Models 4100-9111, -9112, -9113, -9114, -9115, -9116, -9121, -9122, -9131, -9132, -9133, -9211, -9212, -9213, -9222, -9230, -9311, -9312, -9313, -9314, -9315, -9316, -9331, -9332, -9511, -9512, -9513, -9600, -9601 and -9602 fire alarm control units. Power limited, automatic, manual, local, auxiliary, remote station, proprietary and central station, process monitoring, smoke control system, smoke detector monitor, emergency communication and relocation, waterflow and sprinkler supervisory service. Suitable for releasing device service. Models 4100-9111, -9112, -9113, -9114, 9115, -9116, -9121, -9122, -9211, -9212, -9213, -9222, -9311, -9312, -9313, -9314, -9511, -9512 and -9513 suitable for mass notification system as an autonomous control unit. The network display units are suitable for mass notification system system as a central control station. The remote annunciators are suitable for mass notification system system as a local operating console. Refer to listee's data sheet for detailed product description and operational considerations. System components:

4100-7101, -7104, -7113, -7115: Master Controller Assembly
4100-7105: Redundant Master Controller Assembly
4100-7150, -7151, -7152, -7154, -7158, -9833: Master Controller Replacements
4100-5005, -5015: 8-Point Class A IDC Module
4100-1291: Remote Unit Interface Module
4100-3102, -9812: MAPNET II Module
4100-3103: MAPNET/IDNET Isolator Module
4100-6038 RS-232/2120: Communication Module
4100-6014, -6078: Modular Network Interface Module
4100-1293: Printer
4100-6052, -6080: Event Reporting DACT
4100-6053: Point reporting DACT
4100-6067: Contact Closure DACT
4100-6031, -6032, -9827, -9828: City Module
4100-2300, -2320: Expansion Bay
2975-9408 thru -9412: Backbox
2975-9438 thru -9440: Backbox
4100-2101 thru -2103, -2121 thru -2123: Glass Door and Retainer
4100-2104 thru -2106, -2124 thru -2126: Glass Door and Retainer

*Revision 03-28-2018



This listing is based upon technical data submitted by the applicant. CSFM Fire Engineering staff has reviewed the test results and/or other data but does not make an independent verification of any claims. This listing is not an endorsement or recommendation of the item listed. This listing should not be used to verify correct operational requirements or installation criteria. Refer to listee's data sheet, installation instructions and/or other

Date Issued: **July 01, 2018**

Listing Expires **June 30, 2019**

Authorized By: **DAVID CASTILLO, Program Coordinator**
Fire Engineering Division

4100-9849, -9863 : TCP/IP Physical Bridge Assembly (Style 4)
 4100-9850, -9864 : TCP/IP Physical Bridge Assembly (Style 7)
 4100-6056 : Wired Media Card
 4100-6057 : Fiber Optic Media Card
 4100-9620 : Analog Audio Expansion Bay
 4100-9621 : Digital Audio Expansion Bay
 4100-1210 : Analog Audio Controller Card
 4100-1211, -1311 : Digital Audio Controller Card
 4100-1212 thru -1225, 1261, -1262 Analog Audio Amplifier
 4100-1312 thru -1325, -1361, -1362 Analog Audio Amplifier
 4100-1226 thru -1239, 1263, -1264 Digital Audio Amplifier
 4100-1326 thru -1339, -1363, -1364 Digital Audio Amplifier
 4100-1240 : Audio Input Option Card
 4100-1241, -1242: Message Expansion Card
 4100-1243, -1244: Microphone Module
 4100-1245, -1248, -1266: Amplifier Expansion NAC
 4100-1246, -1249, -1267 : Amplifier Class A Adapter
 4100-1252, thru -1255 :Audio Operator Interface Module
 4100-1270 : Master Telephone Assembly
 4100-1271 : Remote Telephone
 4100-1272 : Expansion Phone Card
 4100-1273 : Telephone Class A Adapter
 4100-5116 : Expansion Signal Card
 4100-1259, -1260, -1268 : Constant Supervision NAC Modules
 4100-1265 : Degrade Fail-Safe Microphone Module
 4100-6068 : TFX Interface Module
 4100-6072, 6073, 6074, 6075 : Fiber Optic Modem9402
 4100-9842 : Fiber Modem Audio Expansion Board
 4100-9901 thru -9926, -9930 thru -9939Retro-fit Kits
 4100-5013 : Zone Relay 8-point I/O Security Card
 4100-7153, -7155 : Display Replacement
 4100-9401, -9403, -9423, -9441, -9443: Remote User Interface
 4100-0840 : FUI Controller Memory Add-on Module
 4100-7157 : Expanded Memory CPU Card
 4100-6065 : BMUX Communication Card
 2081-9046 : Coil Supervision Module
 4100-6066 : TFX Loop Card
 4100-5130 : TFX Voltage Regulator Module
 4100-1340 : TFX Audio Interface Module
 4100-1297 : TFX Phone Card
 4100-1298 : TFX Master Telephone with Phone Card
 4100-6069 : BACpac Ethernet Module
 4100-1274 : Microphone Multiplex Module
 4100-6047: Building Network Interface Card
 4190-6104: Remote Service Gateway

*Revision 03-28-2018



This listing is based upon technical data submitted by the applicant. CSFM Fire Engineering staff has reviewed the test results and/or other data but does not make an independent verification of any claims. This listing is not an endorsement or recommendation of the item listed. This listing should not be used to verify correct operational requirements or installation criteria. Refer to listee's data sheet, installation instructions and/or other

Date Issued: **July 01, 2018**Listing Expires **June 30, 2019**

Authorized By: **DAVID CASTILLO**, Program Coordinator
 Fire Engineering Division

CALIFORNIA DEPARTMENT OF FORESTRY & FIRE PROTECTION
OFFICE OF THE STATE FIRE MARSHAL
FIRE ENGINEERING - BUILDING MATERIALS LISTING PROGRAM



LISTING SERVICE

LISTING No. 7300-1273:0506 Page 1 of 1

CATEGORY: 7300 -- FIRE ALARM CONTROL UNIT ACCESSORIES/MISC. DEVICES

LISTEE: Digital Security Controls 95 Bridgeland Ave, Toronto, Ontario M8A 1Y7 Canada
Contact: Dan Nita (905) 760-3000 Fax (905) 760-3020
Email: dnita@tycoint.com

DESIGN: Model LE4010CF LTE Interface. Refer to listee's data sheet for additional detailed product description and operational considerations.

RATING: 120 VAC

INSTALLATION: In accordance with listee's printed installation instructions, NFPA 72, applicable codes & ordinances and in a manner acceptable to the authority having jurisdiction.

MARKING: Listee's name, model number, electrical rating, and UL label.

APPROVAL: Listed as a interface for use with a separately listed fire alarm control unit. Refer to listee's Installation Instruction Manual for details.

NOTE: Burglary and other non-fire functions were not examined.

01-11-18 gt



This listing is based upon technical data submitted by the applicant. CSFM Fire Engineering staff has reviewed the test results and/or other data but does not make an independent verification of any claims. This listing is not an endorsement or recommendation of the item listed. This listing should not be used to verify correct operational requirements or installation criteria. Refer to listee's data sheet, installation instructions and/or other

Date Issued: **July 01, 2018**

Listing Expires **June 30, 2019**

Authorized By: **DAVID CASTILLO, Program Coordinator**
Fire Engineering Division



UL, ULC, CSFM Listed;
FM Approved *

Multi-Application Peripherals

IDNet or MAPNET II Communicating Devices
Addressable Manual Stations

Features

Individually addressable manual fire alarm stations with:

- Power and data supplied via IDNet or MAPNET II addressable communications using a single wire pair
- Operation that complies with ADA requirements
- Visible LED indicator that flashes during communications and is on steady when the station has been activated
- The NO GRIP Single Action Station and Retrofit Kit are available with a more easily operated pull lever for applications where anticipated users may find the standard station lever difficult to activate
- Pull lever that protrudes when alarmed
- Break-rod supplied (use is optional)
- Models are available with single or double action (breakglass or push) operation
- UL listed to Standard 38

Compatible with the following Simplex® control panels:

- Model Series 4007ES, 4008, 4010, 4010ES, 4100ES, 4100U, 4020, 4100, and 4120 fire alarm control panels equipped with either IDNet or MAPNET II communications
- Model Series 2120 Communicating Device Transponders (CDTs) equipped with MAPNET II communications

Compact construction:

- Electronics module enclosure minimizes dust infiltration
- Allows mounting in standard electrical boxes
- Screw terminals for wiring connections

Tamper resistant reset key lock (keyed same as Simplex fire alarm cabinets)

Multiple mounting options:

- Surface or semi-flush with standard boxes or matching Simplex boxes
- Flush mount adapter kit
- Adapters are available for retrofitting to commonly available existing boxes

Description

The Simplex addressable manual station combines the familiar Simplex manual station housing with a compact communication module that is easily installed to satisfy demanding applications. Its integral individual addressable module (IAM) constantly monitors status and communicates changes to the connected control panel via IDNet or MAPNET II communications wiring.

* Refer to page 2 for specific model listings. This product has been approved by the California State Fire Marshal (CSFM) pursuant to Section 13144.1 of the California Health and Safety Code. See CSFM Listing 7150-0026.224 for allowable values and/or conditions concerning material presented in this document. Additional listings may be applicable; contact your local Simplex product supplier for the latest status. Listings and approvals under Simplex Time Recorder Co. are the property of Tyco Fire Protection Products.



4099-9004
Single action



4099-9021
NO GRIP
Single action



4099-9805
NO GRIP
Retrofit kit



4099-9005
Breakglass



4099-9006
Push



With 2099-9828
Institutional
Cover kit

Operation

Activation of the 4099-9004 single action manual station requires a firm downward pull to activate the alarm switch. Completing the action breaks an internal plastic break-rod (visible below the pull lever, use is optional). The use of a break-rod can be a deterrent to vandalism without interfering with the minimum pull requirements needed for easy activation. The pull lever latches into the alarm position and remains extended out of the housing to provide a visible indication.

Single Action NO GRIP Station 4099-9021. For applications such as California Building Code, Title 24, which requires "Controls and operating mechanisms shall be operable with one hand and shall not require tight grasping, pinching or twisting of the wrist" the model 4099-9021 station provides a more easily operated pull lever compared to standard stations. Retrofit of existing stations is available using the 4099-9805 Retrofit kit.

Double Action Stations (Breakglass) require the operator to strike the front mounted hammer to break the glass and expose the recessed pull lever. The pull lever then operates as a single action station.

Double Action Stations (Push Type) require that a spring loaded interference plate (marked PUSH) be pushed back to access the pull lever of the single action station.

Station reset requires the use of a key to reset the manual station lever and deactivate the alarm switch. (If the break-rod is used, it must be replaced.)

Station testing is performed by physical activation of the pull lever. Electrical testing can be also performed by unlocking the station housing to activate the alarm switch.

Addressable Manual Stations Surface Mounting

Preferred Mounting. For surface mounting of these addressable manual stations, the preferred electrical boxes are shown in the illustration to the right.

Additional Mounting Reference. Refer to page 4 for Wiremold box mounting compatibility.

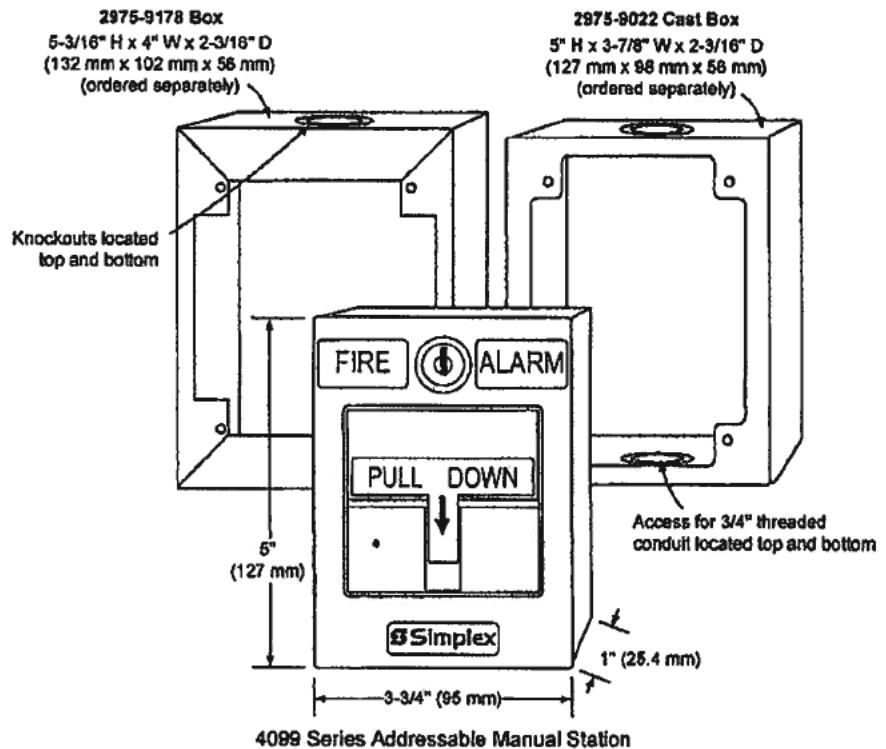

Surface Mount Side View with Internal Detail

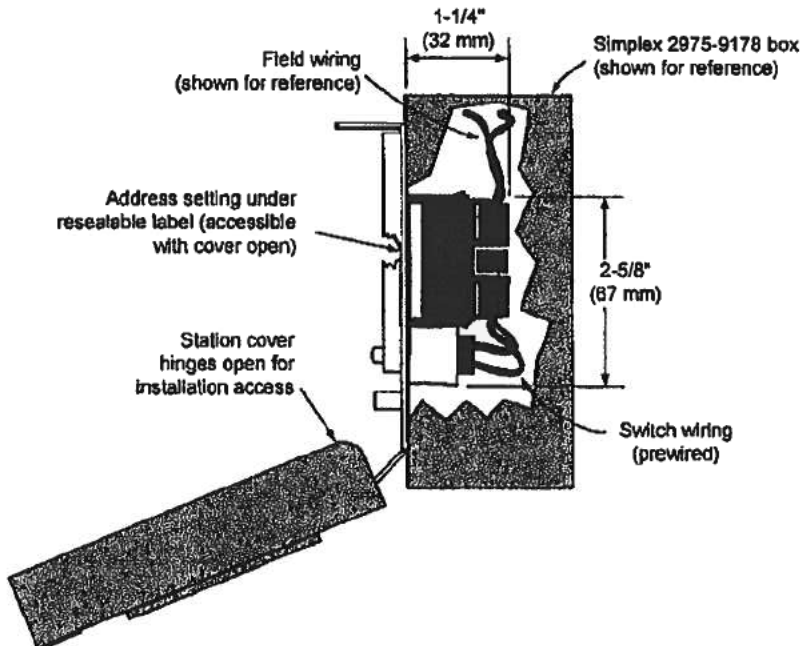

Application Reference

Refer to NFPA 72, the *National Fire Alarm and Signaling Code*, and all applicable local codes for complete requirements for manual stations. The following summarizes the basic requirements.

1. Stations shall be located in the normal path of exit and distributed in the protected area such that they are unobstructed and readily accessible.
2. Mounting shall be with the operable part not less than 42 in (1.07 m) and not more than 48 in (1.22 m) above floor level.
3. At least one station shall be provided on each floor. Additional stations shall be provided to obtain a travel distance not more than 200 ft (61 m) to the nearest station from any point in the building.
4. When manual station coverage appears limited in any way, additional stations should be installed.

CALIFORNIA DEPARTMENT OF FORESTRY & FIRE PROTECTION
OFFICE OF THE STATE FIRE MARSHAL
FIRE ENGINEERING - BUILDING MATERIALS LISTING PROGRAM



LISTING SERVICE

LISTING No. 7150-0026:0224

Page 1 of 1

CATEGORY: 7150 -- FIRE ALARM PULL BOXES

LISTEE: Simplex100 Simplex Drive, Westminster, MA 01441-0001
Contact: Jim Goyette (978) 731-8580 Fax (978) 731-8881
Email: james.goyette@jcl.com

DESIGN: Models 4099-9001, -9002, -9003, *-9004, *-9005, *-9006, -9010, -9011, -9012, *-9013, *-9014, *-9015, -9020, and *-9021 non-coded addressable manual pull stations. Model 4099-9805 Conversion Kit, Models 4099-9001, *-9004, -9010, *-9013, -9020 and *-9021 are single action stations. Models 4099*-9005, -9011 and *-9014 are breakglass stations. Models 4099-9003, *-9006, -9012 and *-9015 include a push bar which must be punched in before being able to grab and pull down the actuating handle. Model 4099-9805 is a retrofit Kit handle for field conversion of a single action station to a NO GRIP station. Refer to listee's data sheet for additional detailed product description and operational considerations.

RATING: 30 VDC

INSTALLATION: In accordance with listee's printed installation instructions, applicable codes and ordinances and in a manner acceptable to the authority having jurisdiction.

MARKING: Listee's name, model number, electrical rating, and UL label.

APPROVAL: Listed as manual pull stations for use with separately listed compatible fire alarm control units. For indoor use only. Refer to listee's Installation Instruction Manual for details. These manual pull boxes meet the requirements of UL Standard 38, 1999 Edition and California amendments.

*Rev. 03-05-14 gt



This listing is based upon technical data submitted by the applicant. CSFM Fire Engineering staff has reviewed the test results and/or other data but does not make an independent verification of any claims. This listing is not an endorsement or recommendation of the item listed. This listing should not be used to verify correct operational requirements or installation criteria. Refer to listee's data sheet, installation instructions and/or other

Date Issued: **July 01, 2018**

Listing Expires **June 30, 2019**

Authorized By: **DAVID CASTILLO, Program Coordinator**
Fire Engineering Division



UL, ULC, CSFM Listed; FM Approved;
MEA (NYC) Acceptance*

TrueAlarm Analog Sensing

TrueAlarm Analog Sensors – Photoelectric
and Heat; Standard Bases and Accessories

Features

TrueAlarm analog sensing provides:

- Digital transmission of analog sensor values via IDNet or MAPNET II two-wire communications

For use with the following Simplex® products:

- 4100ES, 4100U, 4010ES, and 4010 Series control panels; and 4008 Series control panels with reduced feature set (refer to data sheet S4008-0001 for details)
- 4020, 4100, and 4120 Series control panels, Universal Transponders, and 2120 TrueAlarm CDTs equipped for MAPNET II operation

Fire alarm control panel provides:

- Peak value logging allowing accurate analysis of each sensor for individual sensitivity selection
- Sensitivity monitoring satisfying NFPA 72 sensitivity testing requirements; automatic individual sensor calibration check verifies sensor integrity
- Automatic environmental compensation, multi-stage alarm operation, and display of sensitivity directly in percent per foot
- Ability to display and print detailed sensor information in plain English language

Photoelectric smoke sensors provide:

- Seven levels of sensitivity from 0.2% to 3.7% (refer to additional information on page 3)

Heat sensors provide:

- Fixed temperature sensing
- Rate-of-rise temperature sensing
- Utility temperature sensing
- Listed to UL 521 and ULC-S530

General features:

- Listed to UL 268 and ULC-S529
- Louvered smoke sensor design enhances smoke capture by directing flow to chamber; entrance areas are minimally visible when ceiling mounted
- Designed for EMI compatibility
- Magnetic test feature is provided
- Different bases are available to support a supervised or unsupervised output relay, and/or a remote LED alarm indicator

Additional base reference:

- For isolator bases, refer to data sheet S4098-0025
- For sounder bases, refer to data sheet S4098-0028
- For photo/heat sensors, refer to data sheet S4098-0024 (single address) and S4098-0033 (dual address)

* These products have been approved by the California State Fire Marshal (CSFM) pursuant to Section 13144.1 of the California Health and Safety Code. See CSFM Listings 7272-0026:218, 7271-0026:231, 7270-0026:216, and 7300-0026:217 for allowable values and/or conditions concerning material presented in this document. Accepted for use – City of New York Department of Buildings – MEA35-93E. Additional listings may be applicable, contact your local Simplex product supplier for the latest status. Listings and approvals under Simplex Time Recorder Co. are the property of Tyco Fire Protection Products.

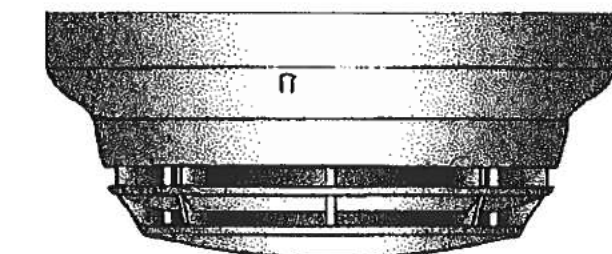

4098-9714 TrueAlarm Photoelectric
Sensor Mounted in Base

Description

Digital Communication of Analog Sensing.

TrueAlarm analog sensors provide an analog measurement digitally communicated to the host control panel using Simplex addressable communications. At the control panel, the data is analyzed and an average value is determined and stored. An alarm or other abnormal condition is determined by comparing the sensor's present value against its average value and time.

Intelligent Data Evaluation. Monitoring each sensor's average value provides a continuously shifting reference point. This software filtering process compensates for environmental factors (dust, dirt, etc.) and component aging, providing an accurate reference for evaluating new activity. With this filtering, there is a significant reduction in the probability of false or nuisance alarms caused by shifts in sensitivity, either up or down.

Control Panel Selection. Peak activity per sensor is stored to assist in evaluating specific locations. The alarm set point for each TrueAlarm sensor is determined at the host control panel, selectable as more or less sensitive as the individual application requires.

Timed/Multi-Stage Selection. Sensor alarm set points can be programmed for timed automatic sensitivity selection (such as more sensitive at night, less sensitive during day). Control panel programming can also provide multi-stage operation per sensor. For example, a 0.2% level may cause a warning to prompt investigation while a 2.5% level may initiate an alarm.

Sensor Alarm and Trouble LED Indication. Each sensor base's LED pulses to indicate communications with the panel. If the control panel determines a sensor is in alarm, or is dirty or has some other type of trouble, the details are annunciated at the control panel and that sensor base's LED will be turned on steadily. During a system alarm, the control panel will control the LEDs such that an LED indicating a trouble will return to pulsing to help identify the alarmed sensors.

TrueAlarm Sensor Bases and Accessories

Sensor Base Features

Base mounted address selection:

- Address remains with its programmed location
- Accessible from front (DIP switch under sensor)

General features:

- Automatic identification provides default sensitivity when substituting sensor types
- Integral red LED for power-on (pulsing), or alarm or trouble (steady on)
- Locking anti-tamper design mounts on standard outlet box
- Magnetically operated functional test

Sensor Bases

4098-9792, Standard Sensor Base

4098-9789, Sensor Base with wired connections for:

- 2098-9808 Remote LED alarm indicator or 4098-9822 relay (relay is unsupervised and requires separate 24 VDC)

Supervised Relay Bases (not compatible with 2120 CDT):

- 4098-9791, 4-Wire Sensor Base, use with remote or locally mounted 2098-9737 relay, requires separate 24 VDC
- 4098-9780, 2-Wire Sensor Base, use with remote or locally mounted 4098-9860 relay, no separate power required
- Supervised relay operation is programmable and can be manually operated from control panel
- Includes wired connections for remote LED alarm indicator or 4098-9822 relay (relay is unsupervised and requires separate 24 VDC)

Sensor Base Options

2098-9737, Remote or local mount supervised relay:

- DPDT contacts for resistive/suppressed loads, power limited rating of 3 A @ 28 VDC; non-power limited rating of 3 A @ 120 VAC (requires external 24 VDC coil power)

4098-9860, Remote or local mount supervised relay:

- SPDT dry contacts, power limited rating of 2 A @ 30 VDC, resistive; non-power limited rating of 0.5 A @ 125 VAC, resistive

4098-9822, LED Annunciation Relay:

- Activates when base LED is on steady, indicating local alarm or trouble
- DPDT contacts for resistive/suppressed loads, power limited rating of 2 A @ 28 VDC; non-power limited rating of 1/2 A @ 120 VAC, (requires external 24 VDC coil power)

4098-9832, Adapter plate:

- Required for surface or semi-flush mounting to 4" square electrical box and for surface mounting to 4" octagonal box
- Can be used for cosmetic retrofitting to existing 6-3/8" diameter base product

2098-9808, Remote red LED Alarm Indicator:

- Mounts on single gang box (shown in illustration to right)

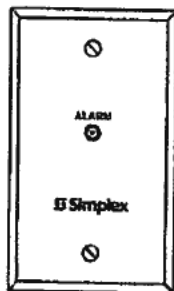

Description

TrueAlarm sensor bases contain integral addressable electronics that constantly monitor the status of the detachable photoelectric or heat sensors. Each sensor's output is digitized and transmitted to the system fire alarm control panel every four seconds.

Since TrueAlarm sensors use the same base, different sensor types can be easily interchanged to meet specific location requirements. This feature also allows intentional sensor substitution during building construction. When conditions are temporarily dusty, instead of covering the smoke sensors (causing them to be disabled), heat sensors may be installed without reprogramming the control panel. Although the control panel will indicate an incorrect sensor type, the heat sensor will operate at a default sensitivity providing heat detection for building protection at that location.

Mounting Reference

Electrical Box Requirements: (boxes are by others)

Without relay in the box: 4" octagonal or 4" square, 1-1/2" deep; single gang, 2" deep

With relay in the box: 4" octagonal or 4" square, 1-1/2" deep, with 1-1/2" extension ring

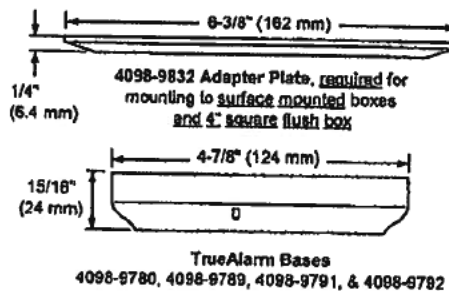
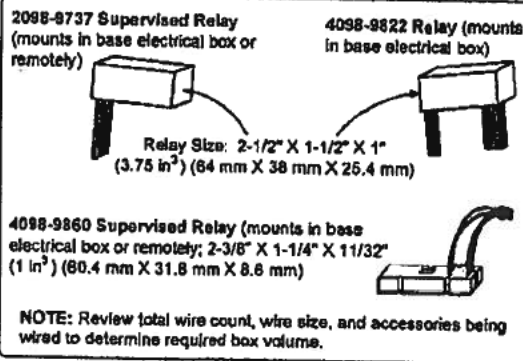
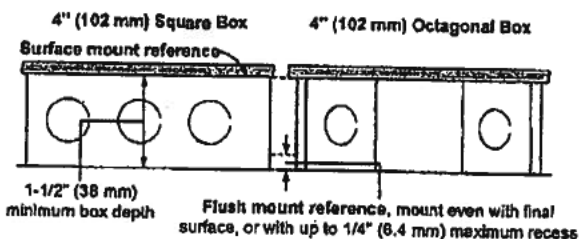

TrueAlarm Sensors

Features

Sealed against rear air flow entry

Interchangeable mounting

EMV/RFI shielded electronics

Heat sensors:

- Selectable rate compensated, fixed temperature sensing with or without rate-of-rise operation
- Rated spacing distance between sensors:

Fixed Temp. Setting	UL & ULC Spacing	FM Spacing, Either Fixed Temperature Setting
135° F (57.2° C)	60 ft x 60 ft (18.3 m)	20 ft x 20 ft (6.1 m) for fixed temperature only; RTI = Quick
155° F (68° C)	40 ft x 40 ft (12.2 m)	50 ft x 50 ft (15.2 m) for fixed temperature with either rate-of-rise selection; RTI = Ultra Fast

Smoke Sensors:

- Photoelectric technology sensing
- 360° smoke entry for optimum response
- Built-in insect screens

4098-9714 Photoelectric Sensor

TrueAlarm photoelectric sensors use a stable, pulsed infrared LED light source and a silicon photodiode receiver to provide consistent and accurate low power smoke sensing. Seven levels of sensitivity are available for each individual sensor, ranging from 0.2% to 3.7% per foot of smoke obscuration. Sensitivities of 0.2%, 0.5%, and 1% are for special applications in clean areas. Standard sensitivities are 1.5%, 2.0%, 2.5%, 3.0%, and 3.7%. Application type and sensitivity are selected and then monitored at the fire alarm control panel.*

The sensor head design provides 360° smoke entry for optimum response to smoke from any direction. Due to its photoelectric operation, air velocity is not normally a factor, except for impact on area smoke flow.

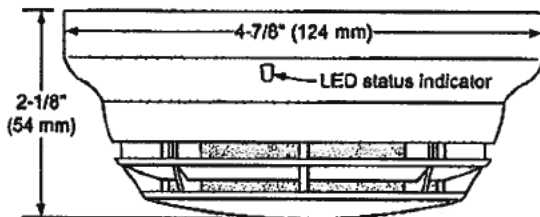

4098-9714 Photoelectric Sensor with Base

4098-9733 Heat Sensor

TrueAlarm heat sensors are self-restoring and provide rate compensated, fixed temperature sensing, selectable with or without rate-of-rise temperature sensing. Due to its small thermal mass, the sensor accurately and quickly measures the local temperature for analysis at the fire alarm control panel.

Rate-of-rise temperature detection is selectable at the control panel for either 15° F (8.3° C) or 20° F (11.1° C) per minute. Fixed temperature sensing is independent of rate-of-rise sensing and programmable to operate at 135° F (57.2° C) or 155° F (68° C). In a slow developing fire, the temperature may not increase rapidly enough to operate the rate-of-rise feature. However, an alarm will be initiated when the temperature reaches its rated fixed temperature setting.

TrueAlarm heat sensors can be programmed as a utility device to monitor for temperature extremes in the range from 32° F to 155° F (0° C to 68° C). This feature can provide freeze warnings or alert to HVAC system problems. Refer to specific panels for availability.

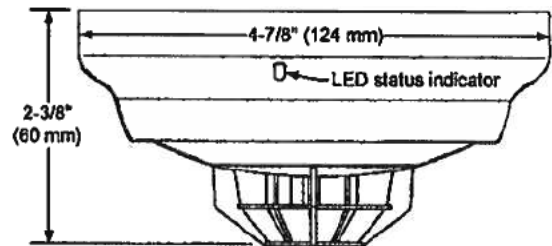

4098-9733 Heat Sensor with Base

WARNING: In most fires, hazardous levels of smoke and toxic gas can build up before a heat detection device would initiate an alarm. In cases where Life Safety is a factor, the use of smoke detection is highly recommended.

Application Reference

Sensor locations should be determined only after careful consideration of the physical layout and contents of the area to be protected. Refer to NFPA 72, the *National Fire Alarm and Signaling Code*. On smooth ceilings, smoke sensor spacing of 30 ft (9.1 m) may be used as a guide.*

* For detailed application information including sensitivity selection, refer to Installation Instructions 574-709.

CALIFORNIA DEPARTMENT OF FORESTRY & FIRE PROTECTION
OFFICE OF THE STATE FIRE MARSHAL
FIRE ENGINEERING - BUILDING MATERIALS LISTING PROGRAM



LISTING SERVICE

LISTING No. 7300-0026:0217 Page 1 of 1

CATEGORY: 7300 – FIRE ALARM CONTROL UNIT ACCESSORIES/MISC. DEVICES

LISTEE: Simplex100 Simplex Drive, Westminster, MA 01441-0001
Contact: Jim Goyette (978) 731-8580 Fax (978) 731-8881
Email: james.goyette@jci.com

DESIGN: Models 4098*-9775, *-9776, *-9777, -9780, -9780E, -9789, -9789E, 9789TSP, -9789TTP, -9791, -9791E, -9791TSP, 9791TTP, -9792, -9792E, -9792TSP, 9792TTP, -9793, -9793E, -9793TSP, -9793TTP, -9796, -9796TSP, -9796TTP; GSA4098-9780, -9792, -9793, and -9796 smoke detector bases. These bases act as an interface between the sensor and the MAPNET controller. Refer to listee's printed data sheet for additional detailed product description and operational considerations.

INSTALLATION: In accordance with listee's printed installation instructions, applicable codes and ordinances and in a manner acceptable to the authority having jurisdiction.

MARKING: Listee's name, model number, electrical rating, and UL label.

APPROVAL: Listed as detector bases for use with listee's separately listed compatible fire alarm control units.
Models 4098-9775, -9776, -9777, -9780, -9780E, -9789, -9789E, 9789TSP, -9789TTP, -9791, -9791E, -9791TSP, 9791TTP, -9792, -9792E, -9792TSP, 9792TTP, -9793, -9793E, -9793TSP, -9793TTP; GSA4098-9780, -9792 and -9793 are intended for use with: Models 4098-9714 and GSA4098-9714 photoelectric smoke detectors (CSFM Listing No. 7272-0026:0218); Model 4098-9717 ionization smoke detector (CSFM Listing No. 7271-0026:0231); and Models 4098-9733, GSA4098-9733, 4098-9734 and GSA4098-9734 heat detectors (CSFM Listing No. 7270-0026:0216).

Models 4098-9796, -9796TSP, -9796TTP, GSA4098-9796 are only intended for use with Models 4098-9754 or GSA4098-9754 photoelectric smoke detector (CSFM Listing No. 7272-0026:0218).

These base/sounders CAN NOT produce the temporal code pattern in accordance with NFPA 72, 2002 Edition. If this temporal code is required, the sounder/base unit must be used with the control unit that can produce the temporal pattern. Refer to listee's Installation Instruction Manual for details.

*Rev. 02-08-18 gt



This listing is based upon technical data submitted by the applicant. CSFM Fire Engineering staff has reviewed the test results and/or other data but does not make an independent verification of any claims. This listing is not an endorsement or recommendation of the item listed. This listing should not be used to verify correct operational requirements or installation criteria. Refer to listee's data sheet, installation instructions and/or other

Date Issued: July 01, 2018

Listing Expires June 30, 2019

Authorized By: DAVID CASTILLO, Program Coordinator
Fire Engineering Division

4100-2111 thru -2113, -2131 thru -2133: Solid Door
 4100-2114 thru -2116, -2134 thru -2136: Solid Door
 2975-9422 thru -9426, -9428, -9429: Enclosure
 2975-9431, -9432: Enclosure
 2975-9441 thru -9452: Enclosure
 4100-0633, -6034: Tamper switch
 4100-9141,-9142,-9151,-9152,-9241 thru -9246,-9342,-9352,-9542 Network Display Unit
 4100-6030, -6055 : Service Modem
 4100-5101, -5102, -5103 : Expansion Power Supply
 4100-5111, -5112, -5113 : System Power Supply
 4100-5125, -5126, -5127: Remote Power Supply
 4100-1288, -1289 : LED/Switch Controller
 4100-1276 thru -1287, -1295, -1299: LED/Switch Module
 4100-1300, -1301, -1302: LED/Switch Module
 4100-1290 24: Point Graphic I/O Module
 4100-9607,-9609,-9610, -9611,-9612,-9614,-9615 Remote Annunciator
 4100-1292: Remote LCD Display
 4100-3115: XA Loop Interface Module
 4100-3101,-3104, -3105, -3106, -3107,-3108,-3109,3110,3111,-9811 IDNET Module
 4100-9116: Addressable IDNET Isolator
 4090-9117: Addressable Power Isolator
 4100-9643: Utility Cabinet
 4100-0634, -0635: Power Distribution Module
 4100-5152, -5153, -5154, 5155: Auxiliary Power Supply
 4100-6033, -9829: Alarm Relay Card
 4100-3201, -3202,-3203,-3204,-3206: Auxiliary Relay Modules
 4100-0620: Basic Transponder Interface Card
 4100-6043, -6044: Converter
 4100-6045: Decoder Module
 4100-6054: Fiber Optic Driver
 4100-5115: Expansion NAC
 4100-9816: Master Clock Interface
 4100-6048: VESDA Interface
 4100-5311,-5313,-5325,-5327: Extended Power Supply
 4100-6103: Dual Class A Isolator
 4100-5120, -5121, -5122: True Alert Power Supply
 4081-9306, -9308: Expansion Battery Charger
 4100-2140: Rack Mount Bay Mounting Kit
 4100-2144 : Rack Mount PDM Mounting Kit
 4100-0156: Eight Volt Converter
 4100-0625: Local Mode Transponder Interface Card
 4601-9100, -9108,-9109,-9110,-9111Local Mode Controller
 4100-0623 : Basic Network Transponder Interface Card
 4100-0621, -0622, -1341:Audio Riser Module
 4100-6036, -6037,-6101,-6102 : Physical Bridge Assembly

*Revision 03-28-2018



This listing is based upon technical data submitted by the applicant. CSFM Fire Engineering staff has reviewed the test results and/or other data but does not make an independent verification of any claims. This listing is not an endorsement or recommendation of the item listed. This listing should not be used to verify correct operational requirements or installation criteria. Refer to listee's data sheet, installation instructions and/or other

Date Issued: **July 01, 2018**Listing Expires **June 30, 2019**

Authorized By: **DAVID CASTILLO, Program Coordinator**
Fire Engineering Division

- *4100-6077 MX Loop Interface Card
- *4100-5124 TrueAlert Class A Adapter
- *4100-5128 Battery Distribution Terminal Module
- *4100-6046 Dual RS232 Interface Module
- *4100-6061 Modular Network Interface Assembly
- *4100-3113 IDNET 2 Sprinkler Card

RATING: 120, 220, 240 VAC primary; 24 VDC secondary

INSTALLATION: In accordance with listee's printed installation instructions, NFPA 72, applicable codes and ordinances and in a manner acceptable to the authority having jurisdiction.

MARKING: Listee's name, model/catalog number, electrical rating, and UL label.

APPROVAL: Listed as fire alarm control units suitable for use with separately listed compatible initiating and indicating devices. Also suitable for high-rise applications. The control unit is compatible with the Model 4090-9007 Signal Individual Addressable Module (CSFM Listing No. 7165-0026:318).

These control units can generate a distinctive three-pulse Temporal Pattern Fire Alarm Evacuation Signal (for total evacuation) in accordance with NFPA 72, 2002 Edition. This control unit meets the requirements of UL-864, 9th Edition Standard.

NOTE:

1. For Fire Alarm Verification feature (delay of the fire alarm signal), the maximum Retard/Reset/Restart period shall not exceed 30 seconds.
2. Combined from 7170-0026:250

*Revision 03-28-2018



This listing is based upon technical data submitted by the applicant. CSFM Fire Engineering staff has reviewed the test results and/or other data but does not make an independent verification of any claims. This listing is not an endorsement or recommendation of the item listed. This listing should not be used to verify correct operational requirements or installation criteria. Refer to listee's data sheet, installation instructions and/or other

Date Issued: **July 01, 2018**

Listing Expires **June 30, 2019**

Authorized By: **DAVID CASTILLO**, Program Coordinator
Fire Engineering Division

SERIES MB MOTOR BELLS



SERIES MB



RSSP STROBE PLATE

Description

Wheelock's Series MB Motor Bells provide a better engineered motor bell for fire and life safety alarm systems. The Wheelock Series MB Bells include higher dBA, low current draw, built-in trimplate for semi-flush mounting, low frequency aluminum shells, and low RFI noise. The motor for Series MB Bells is a durable, high torque permanent magnet motor selected for its high performance and long life.

These DC vibrating Series MB Motor Bells are offered in 6" and 10" shell sizes in both 12 and 24 VDC models.

Series RSSP Sync/Non-Sync strobe plates are used in conjunction with the Series MB Motor Bell when combination appliances are required. The Series RSSP retrofit plates are available with either Multi-Candela or single candela strobes and easily mount to a 4" square or Wheelock SBL-2 backbox.

The Series RSSP retrofit plates may be synchronized when installed with the Wheelock Series DSM, Sync Modules. Wheelock's synchronized strobes offer an easy way to comply with recommendations concerning photo-sensitive epilepsy.

Features

- High sound output with low current draw
- Low frequency aluminum shells for better audibility through walls, doors and other structures
- 6" and 10" shell sizes in 12 or 24 VDC models
- Integral RFI suppression to minimize included noise on the NAC circuit
- Mounting options for surface, semi-flush, outdoor, and concealed conduit installation
- Built-in trimplate makes semi-flush mounting simpler and less expensive.
- Screw terminals permit fast in-out field wiring of #12 to 18 AWG wire.
- Polarized for DC supervision of NAC circuits.
- Operates on filtered or unfiltered DC.
- For combined audible (bell) and visual signaling, convenient strobe plate assemblies are available with Multi-Candela or Single candela strobes

Ordering Information

Model Number	Order Code	Shell Size	Input Voltage (VDC)	Average RMS Current	UL Max*	dBA @ 10 Ft.	Mounting Options
MB-G6-12-R	3942	6"	12	0.060	0.090	92	D,E,J,K,N,O,P,R,S
MB-G6-12-S	4221	6"	12	0.080	0.090		
MB-G6-24-R	3941	6"	24	0.030	0.040		
MB-G6-24-S	4222	6"	24	0.030	0.040		
MB-G10-12-R	3944	10"	12	0.060	0.090		
MB-G10-12-S	4223	10"	12	0.080	0.090		
MB-G10-24-R	3943	10"	24	0.030	0.040		
MB-G10-24-S	4224	10"	24	0.030	0.040		

NOTE:

1. Typical dBA at 10 feet is measured in an anechoic chamber.

CALIFORNIA DEPARTMENT OF FORESTRY & FIRE PROTECTION
OFFICE OF THE STATE FIRE MARSHAL
FIRE ENGINEERING - BUILDING MATERIALS LISTING PROGRAM



LISTING SERVICE

LISTING No. 7135-0785:0113

Page 1 of 1

CATEGORY: 7135 – AUDIBLE DEVICES

LISTEE: Cooper Wheelock Inc. 7246 16th St. E., Ste. 105, Sarasota, FL 34243
Contact: Tom Conover (941) 487-2336
Email: thomas.conover@cooperindustries.com

DESIGN: Model MB series bells and Model MBS series bell/strobes. Models MB are suitable for outdoor use when used with Model WBB backbox. Refer to listee's data sheet for detailed product description and operational considerations.

INSTALLATION: In accordance with listee's printed installation instructions, NFPA 72, applicable codes and ordinances and in a manner acceptable to the authority having jurisdiction.

MARKING: Listee's name, model number, electrical rating and UL label.

APPROVAL: Listed as audible devices for use with separately listed compatible fire alarm control units.

If this appliance is required to produce a distinctive three-pulse Temporal Pattern Fire Alarm Evacuation Signal (for total evacuation) in accordance with NFPA 72, 2002 Edition, the appliance must be used with a fire alarm control unit that can generate the temporal pattern signal. Refer to manufacturer's Installation Manual for details.

*Rev. 06-13-2006



This listing is based upon technical data submitted by the applicant. CSFM Fire Engineering staff has reviewed the test results and/or other data but does not make an independent verification of any claims. This listing is not an endorsement or recommendation of the item listed. This listing should not be used to verify correct operational requirements or installation criteria. Refer to listee's data sheet, installation instructions and/or other

Date Issued: **July 01, 2018**

Listing Expires **June 30, 2019**

Authorized By: **DAVID CASTILLO, Program Coordinator**
Fire Engineering Division

EXHIBIT C

BONDS

**[TO BE PROVIDED FOLLOWING CITY COUNCIL APPROVAL OF THE
AGREEMENT.]**

Bond Number K4041034A

FAITHFUL PERFORMANCE BOND
PUBLIC WORK

(The premium charge on this bond is \$ 869.00, being at
the rate of \$ 2.50 per thousand of the contract price)

KNOW ALL MEN BY THESE PRESENTS:

THAT, WHEREAS the CITY OF COSTA MESA, 77 Fair Drive, Costa Mesa, California 92626, has entered into a contract dated January 21, 2020, which is hereby incorporated by reference herein, with Johnson Controls Fire Protection LP

hereinafter designated as the "Principal," for the work described as follows:

City Hall Fire Alarm Upgrade Project - Phase II

_____ ; and
WHEREAS, said Principal is required by the terms of said contract to furnish a bond for the faithful performance of said contract.

NOW, THEREFORE, We the Principal, and Federal Insurance Company, a corporation organized and existing under the laws of the State of Indiana and duly authorized to transact business under the laws of the State of California, as Surety, are held and firmly bound unto the CITY OF COSTA MESA in the penal sum of Three Hundred Forty Seven Thousand Six Hundred Seventeen and 20/100 Dollars (\$ 347,617.20), lawful money of the United States, for the payment of which sum well and truly to be made, we bind ourselves, our heirs, executors, administrators, and successors, jointly and severally, firmly by these presents.

The Condition Of This Obligation Is Such, That, if the above bounden Principal, his or its heirs, executors, administrators, successors or assigns, shall in all things stand to and abide by, and well and truly keep and perform the covenants, conditions and agreements in the said contract and any alteration thereof made as therein provided, or his or their part, to be kept and performed at the time and in the manner therein specified, and in all respects according to their true intent and meaning, and shall indemnify and save harmless the CITY OF COSTA MESA, its officers and agents, as therein stipulated, then this obligation shall become null and void; otherwise it shall be and remain in full force and virtue.

And the said Surety, for value received, hereby stipulates and agrees that no change, extension of time, alteration or addition to the terms of the contract or to the work to be performed thereunder or the specifications accompanying the same shall in any wise affect its obligations on this bond, and it does hereby waive notice of any such change, extension of time, alteration or addition to the terms of the contract or the work or to the specifications.

IN WITNESS WHEREOF. We have hereunto set our hands and seals this 27th day of January, 2020.

Johnson Controls Fire Protection LP

Samuel Begun
Samuel Begun, Attorney-In-Fact
Federal Insurance Company

City of Costa Mesa Form - Public Work 2/00

Bryan M. Canaschi
Bryan M. Canaschi, Attorney-In-Fact

NOTARY ACKNOWLEDGMENT OF PRINCIPAL:

State of Connecticut

County of Hartford ss.

On this the 27th day of January, 2020, before me, Aimee Perondine, the undersigned officer, personally appeared Samuel Begun, who acknowledged himself/herself to be the Attorney-in-Fact of Johnson Controls Fire Protection LP a corporation, and that s/he as such Attorney-in-Fact, being authorized so to do executed the foregoing instrument for the purposes therein contained, by signing the name of the corporation by himself/herself as Attorney-in-Fact.

In witness whereof I hereunto set my hand.

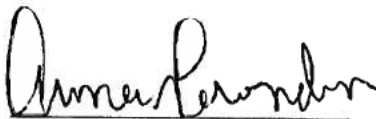

Signature of Notary Public

Date Commission Expires: May 31, 2022

Aimee Perondine

Printed Name of Notary

AIMEE PERONDINE
NOTARY PUBLIC - CT 174145
MY COMMISSION EXPIRES MAY 31, 2022

NOTARY ACKNOWLEDGMENT OF SURETY:

State of Connecticut

County of Hartford ss.

On this the 27th day of January, 2020, before me, Bethany Stevenson, the undersigned officer, personally appeared Bryan M. Caneschi, known to me (or satisfactorily proven) to be the person whose name is subscribed as Attorney-In-Fact for Federal Insurance Company, and acknowledged that s/he executed the same as the act of his/her principal for the purposes therein contained.

In witness whereof I hereunto set my hand.



Signature of Notary Public
Date Commission Expires: September 30, 2023
Bethany Stevenson
Printed Name of Notary

BETHANY STEVENSON
NOTARY PUBLIC - CT 177501
MY COMMISSION EXPIRES SEPT. 30, 2023



DELEGATION OF AUTHORITY

The undersigned, Authorized Signatory of Johnson Controls Fire Protection LP, a Delaware limited partnership (the "Company"), pursuant to the authority vested in him by a certain Delegation of Authority Certificate issued by the Company on June 12, 2019, hereby authorizes:

**Samuel Begun
Assistant Client Services Specialist
Willis Towers Watson
10 State House Sq., Floor 11
Hartford, CT 06103**

to perform, on behalf of the Company, the acts described below:

To execute, seal and deliver, as attorney-in-fact for the Company, surety bonds forwarded to Willis of New York, Inc. by the Company that do not exceed Two Million Dollars (\$2,000,000.00) that are necessary and proper in carrying on the business of the Company.

This authority shall remain in full force and effect for one (1) year from the date of issue unless earlier revoked in writing by the undersigned or the Company President or any Vice President.

Signed at Milwaukee, Wisconsin, this 27th day of January 2020.

A handwritten signature in black ink, appearing to read "Craig Bartol".

Craig Bartol, Authorized Signatory

CHUBB

Power of Attorney

Federal Insurance Company | Vigilant Insurance Company | Pacific Indemnity Company

Know All by These Presents, That **FEDERAL INSURANCE COMPANY**, an Indiana corporation, **VIGILANT INSURANCE COMPANY**, a New York corporation, and **PACIFIC INDEMNITY COMPANY**, a Wisconsin corporation, do each hereby constitute and appoint Alza Anderson, Samuel E. Begun, Bryan M. Caneschi, Lorina Monique Garcia, Danielle D Johnson, Michelle Anna McMahon, Tanya Nguyen, Almee R Perondine, Mercedes Phothirath, Kristopher Pisano, Donna M Planeta, Joshua Sanford, Bethany Stevenson, Rebecca M. Stevenson, Eric Strba and Nicholas Turecamo of Hartford, Connecticut

each as their true and lawful Attorney-in-Fact to execute under such designation in their names and to affix their corporate seals to and deliver for and on their behalf as surety thereon or otherwise, bonds and undertakings and other writings obligatory in the nature thereof (other than bail bonds) given or executed in the course of business, and any instruments amending or altering the same, and consents to the modification or alteration of any instrument referred to in said bonds or obligations.

In Witness Whereof, said **FEDERAL INSURANCE COMPANY**, **VIGILANT INSURANCE COMPANY**, and **PACIFIC INDEMNITY COMPANY** have each executed and attested these presents and affixed their corporate seals on this 17th day of April, 2019.

Dawn M. Chloros

Dawn M. Chloros, Assistant Secretary

Stephen M. Haney

Stephen M. Haney, Vice President



STATE OF NEW JERSEY

County of Hunterdon

ss.

On this 17th day of April, 2019, before me, a Notary Public of New Jersey, personally came Dawn M. Chloros, to me known to be Assistant Secretary of **FEDERAL INSURANCE COMPANY**, **VIGILANT INSURANCE COMPANY**, and **PACIFIC INDEMNITY COMPANY**, the companies which executed the foregoing Power of Attorney, and the said Dawn M. Chloros, being by me duly sworn, did depose and say that she is Assistant Secretary of **FEDERAL INSURANCE COMPANY**, **VIGILANT INSURANCE COMPANY**, and **PACIFIC INDEMNITY COMPANY** and knows the corporate seals thereof, that the seals affixed to the foregoing Power of Attorney are such corporate seals and were thereto affixed by authority of said Companies; and that she signed said Power of Attorney as Assistant Secretary of said Companies by like authority; and that she is acquainted with Stephen M. Haney, and knows him to be Vice President of said Companies; and that the signature of Stephen M. Haney, subscribed to said Power of Attorney is in the genuine handwriting of Stephen M. Haney, and was thereto subscribed by authority of said Companies and in deponent's presence.

Notarial Seal



ROSE CURTIS
NOTARY PUBLIC OF NEW JERSEY
No. 60072408
Commission Expires November 22, 2022

Rose Curtis

Notary Public

CERTIFICATION

Resolutions adopted by the Boards of Directors of **FEDERAL INSURANCE COMPANY**, **VIGILANT INSURANCE COMPANY**, and **PACIFIC INDEMNITY COMPANY** on August 30, 2016:

"RESOLVED, that the following authorizations relate to the execution, for and on behalf of the Company, of bonds, undertakings, recognizances, contracts and other written commitments of the Company entered into in the ordinary course of business (each a "Written Commitment"):

- (1) Each of the Chairman, the President and the Vice Presidents of the Company is hereby authorized to execute any Written Commitment for and on behalf of the Company, under the seal of the Company or otherwise.
- (2) Each duly appointed attorney-in-fact of the Company is hereby authorized to execute any Written Commitment for and on behalf of the Company, under the seal of the Company or otherwise, to the extent that such action is authorized by the grant of powers provided for in such person's written appointment as such attorney-in-fact.
- (3) Each of the Chairman, the President and the Vice Presidents of the Company is hereby authorized, for and on behalf of the Company, to appoint in writing any person the attorney-in-fact of the Company with full power and authority to execute, for and on behalf of the Company, under the seal of the Company or otherwise, such Written Commitments of the Company as may be specified in such written appointment, which specification may be by general type or class of Written Commitments or by specification of one or more particular Written Commitments.
- (4) Each of the Chairman, the President and the Vice Presidents of the Company is hereby authorized, for and on behalf of the Company, to delegate in writing to any other officer of the Company the authority to execute, for and on behalf of the Company, under the Company's seal or otherwise, such Written Commitments of the Company as are specified in such written delegation, which specification may be by general type or class of Written Commitments or by specification of one or more particular Written Commitments.
- (5) The signature of any officer or other person executing any Written Commitment or appointment or delegation pursuant to this Resolution, and the seal of the Company, may be affixed by facsimile on such Written Commitment or written appointment or delegation.

FURTHER RESOLVED, that the foregoing Resolution shall not be deemed to be an exclusive statement of the powers and authority of officers, employees and other persons to act for and on behalf of the Company, and such Resolution shall not limit or otherwise affect the exercise of any such power or authority otherwise validly granted or vested."

I, Dawn M. Chloros, Assistant Secretary of **FEDERAL INSURANCE COMPANY**, **VIGILANT INSURANCE COMPANY**, and **PACIFIC INDEMNITY COMPANY** (the "Companies") do hereby certify that

- (1) the foregoing Resolutions adopted by the Board of Directors of the Companies are true, correct and in full force and effect,
- (2) the foregoing Power of Attorney is true, correct and in full force and effect.

Given under my hand and seals of said Companies at Whitehouse Station, NJ, this January 27, 2020



Dawn M. Chloros

Dawn M. Chloros, Assistant Secretary

IN THE EVENT YOU WISH TO VERIFY THE AUTHENTICITY OF THIS BOND OR NOTIFY US OF ANY OTHER MATTER, PLEASE CONTACT US AT:
Telephone (908) 903-3493 Fax (908) 903-3656 e-mail: surety@chubb.com

**LABOR AND MATERIAL BOND TO ACCOMPANY CONTRACT
PUBLIC WORK**

KNOW ALL MEN BY THESE PRESENTS:

THAT, WHEREAS the CITY OF COSTA MESA, 77 Fair Drive, Costa Mesa, California 92626, has awarded to Johnson Controls Fire Protection LP hereinafter designated as the "Contractor," a contract which is hereby incorporated by reference herein, for the work described as follows: City Hall Fire Alarm Upgrade Project - Phase II

_____ ; and
WHEREAS, said Contractor is required by the provisions of Chapter 7, Division 3, Title 15, Sections 3247-3248, Civil Code to furnish a bond in connection with said contract, as hereinafter set forth.

NOW, THEREFORE, We Johnson Controls Fire Protection LP

the undersigned Contractor, as Principal, and Federal Insurance Company, a corporation organized and existing under the laws of the State of Indiana and duly authorized to transact business under the laws of the State of California, as Surety, are held and firmly bound unto the CITY OF COSTA MESA in the penal sum of Three Hundred Forty Seven Thousand Six Hundred Seventeen and 20/100 Dollars (\$ 347,617.20), said sum being not less than one-half of the estimated amount payable by the said CITY OF COSTA MESA under the terms of the contract. for which payment well and truly to be made, we bind ourselves, our heirs, executors and administrators, successors and assigns, jointly and severally, firmly by these presents.

The Condition Of This Obligation Is Such, That, if said Contractor, his or its heirs, executors, administrators, successors or assigns, or sub-contractors, shall fail to pay for any materials, provisions, provender or other supplies or teams, implements or machinery used in, upon, for or about the performance of the work contracted to be done, or for any work or labor thereon of any kind, or for amounts due under the Unemployment Insurance Code with respect to such work or labor performed under the above contract, or for any amounts required to be deducted, withheld, and paid over to the Employment Development Department from the wages of employees of the Contractor and sub-contractors pursuant to Section 13020 of the Unemployment Insurance Code with respect to such work and labor, the surety or sureties herein will pay for the same in an amount not exceeding the sum specified in this bond, otherwise the above obligation shall be void. In case suit is brought upon this bond, the said Surety will pay a reasonable attorney's fee to be fixed by the court. This bond shall inure to the benefit of any and all persons, companies and corporations entitled to file claims under Section 3181 of the Civil Code, so as to give a right of action to them or their assigns in any suit brought upon this bond. And the said Surety, for value received, hereby stipulates and agrees that no change, extension of time, alteration or addition to the terms of the contract or to the work to be performed thereunder or the specifications accompanying the same shall in any wise affect its obligations on this bond, and it does hereby waive notice of any such change, extension of time, alteration or addition to the terms of the contract or to the work or to the specifications.

IN WITNESS WHEREOF, We have hereunto set our hands and seals this 27th day of January, 2020.

Johnson Controls Fire Protection LP
Samuel Begun
Samuel Begun, Attorney-in-Fact
Federal Insurance Company
Bryan M. Caneachi
Bryan M. Caneachi, Attorney-in-Fact

NOTARY ACKNOWLEDGMENT OF PRINCIPAL:

State of Connecticut

County of Hartford ss.

On this the 27th day of January, 2020, before me, Aimee Perondine, the undersigned officer, personally appeared Samuel Begun, who acknowledged himself/herself to be the Attorney-in-Fact of Johnson Controls Fire Protection LP a corporation, and that s/he as such Attorney-in-Fact, being authorized so to do executed the foregoing instrument for the purposes therein contained, by signing the name of the corporation by himself/herself as Attorney-in-Fact.

In witness whereof I hereunto set my hand.



Signature of Notary Public

Date Commission Expires: May 31, 2022

Aimee Perondine

Printed Name of Notary

AIMEE PERONDINE
NOTARY PUBLIC - CT 174145
MY COMMISSION EXPIRES MAY 31, 2022

NOTARY ACKNOWLEDGMENT OF SURETY:

State of Connecticut

County of Hartford ss.

On this the 27th day of January, 2020, before me, Bethany Stevenson, the undersigned officer, personally appeared Bryan M. Caneschi, known to me (or satisfactorily proven) to be the person whose name is subscribed as Attorney-In-Fact for Federal Insurance Company, and acknowledged that s/he executed the same as the act of his/her principal for the purposes therein contained.

In witness whereof I hereunto set my hand.

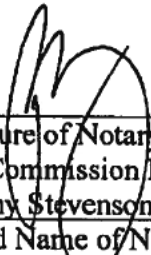

Signature of Notary Public
Date Commission Expires: September 30, 2023
Bethany Stevenson
Printed Name of Notary

BETHANY STEVENSON
NOTARY PUBLIC - CT 177501
MY COMMISSION EXPIRES SEPT. 30, 2023



DELEGATION OF AUTHORITY

The undersigned, Authorized Signatory of Johnson Controls Fire Protection LP, a Delaware limited partnership (the "Company"), pursuant to the authority vested in him by a certain Delegation of Authority Certificate issued by the Company on June 12, 2019, hereby authorizes:

Samuel Begun
Assistant Client Services Specialist
Willis Towers Watson
10 State House Sq., Floor 11
Hartford, CT 06103

to perform, on behalf of the Company, the acts described below:

To execute, seal and deliver, as attorney-in-fact for the Company, surety bonds forwarded to Willis of New York, Inc. by the Company that do not exceed Two Million Dollars (\$2,000,000.00) that are necessary and proper in carrying on the business of the Company.

This authority shall remain in full force and effect for one (1) year from the date of issue unless earlier revoked in writing by the undersigned or the Company President or any Vice President.

Signed at Milwaukee, Wisconsin, this 27th day of January 2020.

A handwritten signature in black ink, appearing to read "Craig Bartol".

Craig Bartol, Authorized Signatory

CHUBB'

Power of Attorney

Federal Insurance Company | Vigilant Insurance Company | Pacific Indemnity Company

Know All by These Presents, That **FEDERAL INSURANCE COMPANY**, an Indiana corporation, **VIGILANT INSURANCE COMPANY**, a New York corporation, and **PACIFIC INDEMNITY COMPANY**, a Wisconsin corporation, do each hereby constitute and appoint Alza Anderson, Samuel E. Begun, Bryan M. Caneschi, Lorina Monique Garcia, Danielle D Johnson, Michelle Anne McMahon, Tanya Nguyen, Almee R Perondine, Mercedes Phothirath, Kristopher Pisano, Donna M Planeta, Joshua Sanford, Bethany Stevenson, Rebecca M. Stevenson, Eric Strba and Nicholas Turecamo of Hartford, Connecticut

each as their true and lawful Attorney-in-Fact to execute under such designation in their names and to affix their corporate seals to and deliver for and on their behalf as surety thereon or otherwise, bonds and undertakings and other writings obligatory in the nature thereof (other than ball bonds) given or executed in the course of business, and any instruments amending or altering the same, and consents to the modification or alteration of any instrument referred to in said bonds or obligations.

In Witness Whereof, said **FEDERAL INSURANCE COMPANY**, **VIGILANT INSURANCE COMPANY**, and **PACIFIC INDEMNITY COMPANY** have each executed and attested these presents and affixed their corporate seals on this 17th day of April, 2019.

Dawn M. Chloros

Dawn M. Chloros, Assistant Secretary

Stephen M. Haney

Stephen M. Haney, Vice President



STATE OF NEW JERSEY

County of Hunterdon

ss.

On this 17th day of April, 2019, before me, a Notary Public of New Jersey, personally came Dawn M. Chloros, to me known to be Assistant Secretary of **FEDERAL INSURANCE COMPANY**, **VIGILANT INSURANCE COMPANY**, and **PACIFIC INDEMNITY COMPANY**, the companies which executed the foregoing Power of Attorney, and the said Dawn M. Chloros, being by me duly sworn, did depose and say that she is Assistant Secretary of **FEDERAL INSURANCE COMPANY**, **VIGILANT INSURANCE COMPANY**, and **PACIFIC INDEMNITY COMPANY** and knows the corporate seals thereof, that the seals affixed to the foregoing Power of Attorney are such corporate seals and were thereto affixed by authority of said Companies; and that she signed said Power of Attorney as Assistant Secretary of said Companies by like authority; and that she is acquainted with Stephen M. Haney, and knows him to be Vice President of said Companies; and that the signature of Stephen M. Haney, subscribed to said Power of Attorney is in the genuine handwriting of Stephen M. Haney, and was thereto subscribed by authority of said Companies and in deponent's presence.

Notarial Seal



ROSE CURTIS
NOTARY PUBLIC OF NEW JERSEY
No. 60072400
Commission Expires November 22, 2022

Rose Curtis
Notary Public

CERTIFICATION

Resolutions adopted by the Boards of Directors of **FEDERAL INSURANCE COMPANY**, **VIGILANT INSURANCE COMPANY**, and **PACIFIC INDEMNITY COMPANY** on August 30, 2016:

"RESOLVED, that the following authorizations relate to the execution, for and on behalf of the Company, of bonds, undertakings, recognizances, contracts and other written commitments of the Company entered into in the ordinary course of business (each a "Written Commitment"):

- (1) Each of the Chairman, the President and the Vice Presidents of the Company is hereby authorized to execute any Written Commitment for and on behalf of the Company, under the seal of the Company or otherwise.
- (2) Each duly appointed attorney-in-fact of the Company is hereby authorized to execute any Written Commitment for and on behalf of the Company, under the seal of the Company or otherwise, to the extent that such action is authorized by the grant of powers provided for in such person's written appointment as such attorney-in-fact.
- (3) Each of the Chairman, the President and the Vice Presidents of the Company is hereby authorized, for and on behalf of the Company, to appoint in writing any person the attorney-in-fact of the Company with full power and authority to execute, for and on behalf of the Company, under the seal of the Company or otherwise, such Written Commitments of the Company as may be specified in such written appointment, which specification may be by general type or class of Written Commitments or by specification of one or more particular Written Commitments.
- (4) Each of the Chairman, the President and the Vice Presidents of the Company is hereby authorized, for and on behalf of the Company, to delegate in writing to any other officer of the Company the authority to execute, for and on behalf of the Company, under the Company's seal or otherwise, such Written Commitments of the Company as are specified in such written delegation, which specification may be by general type or class of Written Commitments or by specification of one or more particular Written Commitments.
- (5) The signature of any officer or other person executing any Written Commitment or appointment or delegation pursuant to this Resolution, and the seal of the Company, may be affixed by facsimile on such Written Commitment or written appointment or delegation.

FURTHER RESOLVED, that the foregoing Resolution shall not be deemed to be an exclusive statement of the powers and authority of officers, employees and other persons to act for and on behalf of the Company, and such Resolution shall not limit or otherwise affect the exercise of any such power or authority otherwise validly granted or vested."

I, Dawn M. Chloros, Assistant Secretary of **FEDERAL INSURANCE COMPANY**, **VIGILANT INSURANCE COMPANY**, and **PACIFIC INDEMNITY COMPANY** (the "Companies") do hereby certify that

- (i) the foregoing Resolutions adopted by the Board of Directors of the Companies are true, correct and in full force and effect,
- (ii) the foregoing Power of Attorney is true, correct and in full force and effect.

Given under my hand and seals of said Companies at Whitehouse Station, NJ, this January 27, 2020



Dawn M. Chloros

Dawn M. Chloros, Assistant Secretary

IN THE EVENT YOU WISH TO VERIFY THE AUTHENTICITY OF THIS BOND OR NOTIFY US OF ANY OTHER MATTER, PLEASE CONTACT US AT:
Telephone (908) 903-3493 Fax (908) 903-3656 e-mail: surety@chubb.com

EXHIBIT D

SUMMARY OF PUBLIC CONTRACT CODE SECTION 9204

SUMMARY OF PUBLIC CONTRACT CODE § 9204

The following procedure will apply to any claims by the Contractor on the City:

A “claim” is a separate demand on the City by a contractor on a public works project and sent by registered mail or certified mail with return receipt requested, for one or more of the following:

- A time extension, including relief from penalties for delay
- Payment by the City of money damages under the terms of the contract
- Payment of an amount that is disputed by the City

Initial Review

The claim must be supported by appropriate documentation. The City has 45 days within which to review the claim and provide the contractor with a written statement identifying the disputed and undisputed portions of the claim. If the City does not issue a written statement, the claim is deemed rejected in its entirety. The City will pay any undisputed portion of the claim within 60 days of issuing the statement.

Meet & Confer

If the contractor disputes the City’s written response, or if the City does not issue one, the contractor may request in writing an informal conference to meet and confer for possible settlement of the claim. The City will schedule the meet and confer conference within 30 days of this request and provide a written statement identifying the remaining disputed and undisputed portions of the claim within 10 business days of the meet and confer. The City will pay the undisputed portion within 60 days of issuing this statement.

Mediation

With respect to any disputed portion remaining after the meet and confer, the City and contractor will submit the matter to nonbinding mediation, agree to a mediator within 10 business days after issuing the written statement, and share mediation costs equally. If mediation is unsuccessful, then the terms of the public works agreement and applicable law will govern resolution of the dispute.

Miscellaneous Provisions

Amounts not paid by the City in a timely manner bear interest at 7% per annum. Subcontractors may submit claims via this procedure through the general contractor. The City and contractor may waive the requirement to mediate, but cannot otherwise waive these claim procedures.

EXHIBIT E
DRUG-FREE WORKPLACE POLICY

CITY OF COSTA MESA, CALIFORNIA

COUNCIL POLICY

SUBJECT	POLICY NUMBER	EFFECTIVE DATE	PAGE
DRUG-FREE WORKPLACE	100-5	8-8-89	1 of 3

BACKGROUND

Under the Federal Drug-Free Workplace Act of 1988, passed as part of omnibus drug legislation enacted November 18, 1988, contractors and grantees of Federal funds must certify that they will provide drug-free workplaces. At the present time, the City of Costa Mesa, as a sub-grantee of Federal funds under a variety of programs, is required to abide by this Act. The City Council has expressed its support of the national effort to eradicate drug abuse through the creation of a Substance Abuse Committee, institution of a City-wide D.A.R.E. program in all local schools and other activities in support of a drug-free community. This policy is intended to extend that effort to contractors and grantees of the City of Costa Mesa in the elimination of dangerous drugs in the workplace.

PURPOSE

It is the purpose of this Policy to:

1. Clearly state the City of Costa Mesa's commitment to a drug-free society.
2. Set forth guidelines to ensure that public, private, and nonprofit organizations receiving funds from the City of Costa Mesa share the commitment to a drug-free workplace.

POLICY

The City Manager, under direction by the City Council, shall take the necessary steps to see that the following provisions are included in all contracts and agreements entered into by the City of Costa Mesa involving the disbursement of funds.

1. Contractor or Sub-grantee hereby certifies that it will provide a drug-free workplace by:
 - A. Publishing a statement notifying employees that the unlawful manufacture, distribution, dispensing, possession, or use of a controlled substance is prohibited in Contractor's and/or sub-grantee's workplace, specifically the job site or location included in this contract, and specifying the actions that will be taken against the employees for violation of such prohibition;
 - B. Establishing a Drug-Free Awareness Program to inform employees about:

SUBJECT	POLICY NUMBER	EFFECTIVE DATE	PAGE
DRUG-FREE WORKPLACE	100-5	8-8-89	2 of 3

1. The dangers of drug abuse in the workplace;
 2. Contractor's and/or sub-grantee's policy of maintaining a drug-free workplace;
 3. Any available drug counseling, rehabilitation and employee assistance programs; and
 4. The penalties that may be imposed upon employees for drug abuse violations occurring in the workplace;
- C. Making it a requirement that each employee to be engaged in the performance of the contract be given a copy of the statement required by subparagraph A;
- D. Notifying the employee in the statement required by subparagraph 1 A that, as a condition of employment under the contract, the employee will:
1. Abide by the terms of the statement; and
 2. Notify the employer of any criminal drug statute conviction for a violation occurring in the workplace no later than five (5) days after such conviction;
- E. Notifying the City of Costa Mesa within ten (10) days after receiving notice under subparagraph 1 D 2 from an employee or otherwise receiving the actual notice of such conviction;
- F. Taking one of the following actions within thirty (30) days of receiving notice under subparagraph 1 D 2 with respect to an employee who is so convicted:
1. Taking appropriate personnel action against such an employee, up to and including termination; or
 2. Requiring such employee to participate satisfactorily in a drug abuse assistance or rehabilitation program approved for such purposes by a Federal, State, or local health agency, law enforcement, or other appropriate agency;

SUBJECT	POLICY NUMBER	EFFECTIVE DATE	PAGE
DRUG-FREE WORKPLACE	100-5	8-8-89	3 of 3

- G. Making a good faith effort to maintain a drug-free workplace through implementation of subparagraphs 1 A through 1 F, inclusive.
2. Contractor and/or sub-grantee shall be deemed to be in violation of this Policy if the City of Costa Mesa determines that:
 - a. Contractor and/or sub-grantee has made a false certification under paragraph 1 above;
 - b. Contractor and/or sub-grantee has violated the certification by failing to carry out the requirements of subparagraphs 1 A through 1 G above;
 - c. Such number of employees of Contractor and/or sub-grantee have been convicted of violations of criminal drug statutes for violations occurring in the workplace as to indicate that the contractor and/or sub-grantee has failed to make a good faith effort to provide a drug-free workplace.
 3. Should any contractor and/or sub-grantee be deemed to be in violation of this Policy pursuant to the provisions of 2 A, B, and C, a suspension, termination or debarment proceeding subject to applicable Federal, State, and local laws shall be conducted. Upon issuance of any final decision under this section requiring debarment of a contractor and/or sub-grantee, the contractor and/or sub-grantee shall be ineligible for award of any contract, agreement or grant from the City of Costa Mesa for a period specified in the decision, not to exceed five (5) years. Upon issuance of any final decision recommending against debarment of the contractor and/or sub-grantee, the contractor and/or sub-grantee shall be eligible for compensation as provided by law.